

# CULTURAL RESOURCE ASSESSMENT SURVEY OF INFRASTRUCTURE REPAIR AND TRAIL REBUILDING WITHIN HONTOON ISLAND STATE PARK

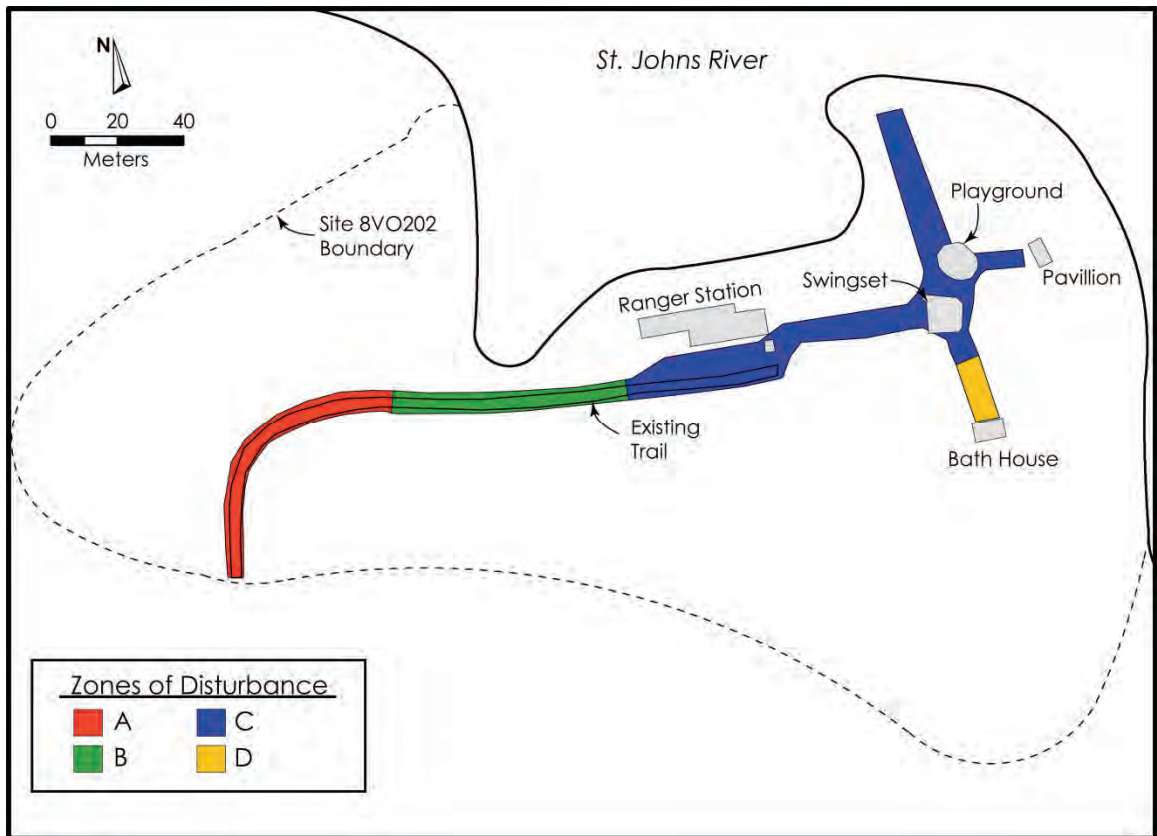

Asa R. Randall and Kenneth E. Sassaman

Technical Report 9  
Laboratory of Southeastern Archaeology  
Department of Anthropology  
University of Florida



**CULTURAL RESOURCE ASSESSMENT SURVEY OF INFRASTRUCTURE REPAIR  
AND TRAIL REBUILDING WITHIN HONTOON ISLAND STATE PARK**

Asa R. Randall and Kenneth E. Sassaman

Technical Report 9  
Laboratory of Southeastern Archaeology  
Department of Anthropology  
University of Florida  
Gainesville, FL 32611

April 2009

© 2009 Department of Anthropology, University of Florida  
all rights reserved

## Management Summary

The Laboratory of Southeastern Archaeology (LSA) of the Department of Anthropology, University of Florida, conducted archaeological investigations at Hontoon Island State Park in March 2009 in advance of planned below-ground infrastructure repair and trail refurbishment. Within the area of potential effect (APE) the proposed repairs will involve (a) excavation of trenches to a minimum depth of 36 in below surface, and (b) excavation of trail beds and associated trenches to a minimum depth of 45 in below surface. The archaeological reconnaissance was conducted under 1A-32 Permit #0809.056

A literature review determined that the project falls within the boundaries of sites 8VO202, Hontoon Island North, and 8VO2600, the Thursby Midden/Hontoon Island Parking Lot. Site 8VO202 was once one of the largest shell mound complexes in northeast Florida, and site 8VO2600 was the locus of an extensive shell ridge and sand burial mound. Although both sites have been heavily impacted by 20<sup>th</sup>-century land use practices, each contains the potential for significant intact deposits. Testing strategies were implemented to identify the minimum depth below surface of intact deposits within known site boundaries, and consisted of excavation of shovel test pits (STPs) or auger tests at 10-m intervals. Outside of known site boundaries, testing consisted of STPs at 30-m intervals along the project corridor.

Testing of site 8VO2600, the Thursby midden, was limited to a single auger test adjacent to the APE. A single human tooth was recovered at a depth of 70 cm below surface in the first auger test conducted. At the request of BAR archaeologists, no further testing was conducted within the boundaries of 8VO2600. Because of the limited scope of the auger test, it is unknown if this tooth was in primary context. However, the depth of discovery is consistent with previous stratigraphic observations in the vicinity of the APE.

Within the confines of the Hontoon Island North site (8VO202), testing resulted in a total of 38 STPs and 3 judgmental auger tests. Excavations revealed intact archaeological deposits at variable depths within most of the APE. Based on the results of testing, we have identified four zones of disturbance. These zones have been defined by the depth of intact deposits and the likely significance of archaeological resources within them. Zones A and B lie within the expected trail regrading area, while C and D will be impacted by water main replacement. Zone A is located along the western side of 8VO202 and corresponds roughly with the bend in the trail. Testing indicates that concreted shell midden likely dating to the Archaic period (ca. 6200-4100 BP) is present between 10 and 40 cm below surface (BS). Previous archaeological investigations in this locus identified an Archaic period burial, as well as dispersed fragments of human bone. Zone B roughly corresponds with a low-lying area adjacent to the harbor. Intact deposits are present between 30 and 50 cm BS, but are generally thin and defuse, and lying atop a culturally sterile basal sand. Zone C intersects an area of deep disturbance by modern land use practices. In all but a few cases, fill consisting of sand, peat, and displaced shell midden was emplaced here to build up the current landform. An intact post-mining

surface with historic remains is present between 45 and 70 cm BS. This stratum also yielded isolated human skeletal remains in one STP. Intact archaeological deposits of the St. Johns era (ca. 2500-500 BP) were located at the very bottom of STPs. Zone D is situated south of the current swing set, and corresponds to a distinct topographic rise to the south. The two STPs here identified intact deposits starting between 15 and 20 cm BS.

Finally, testing the remainder of the trail corridor and select water service laterals did not encounter any intact archaeological deposits south of 8VO202. A total of 29 STPs were excavated along this portion of the APE. Areas around the ranger houses and the water treatment plant away from the trail were not tested because of the presence of unmarked utilities. However, no archaeological resources were identified in nearby STPs, and none are expected based on the similarity in contexts to other tested areas.

Based on the results of the reconnaissance survey, the LSA recommends the following actions to limit the disturbance to subsurface cultural resources. Within 8VO2600, the excavation of the utility corridor from the main line tie-in at the north end of the parking lot to the directional drill location at the south end of the parking lot should be monitored by a professional archaeologist. Within 8VO202, Zone A should be closely monitored by a professional archaeologist. Further work may be necessary to characterize the nature and significance of intact deposits. Zone B should be monitored by a professional archaeologist during trail excavation and trenching. Trenching within Zone C should not significantly impact archaeological deposits as long as depth specifications for the trench are adhered to. However, the excavation of the lateral service water line adjacent to the pavilion should be monitored, based the recovery of human remains during testing. Zone D should be monitored by a professional archaeologist during trenching. Any ancillary activities that may impact subsurface deposits in the vicinity of site 8VO2600, and Zones A, B, and D at 8VO202 should be avoided. Work outside of the boundaries of 8VO202 and 8VO2600 can proceed without further archaeological intervention.

## CONTENTS

Management Summary .....	iii
Chapter 1. Project Overview.....	1
Chapter 2. Environmental and Archaeological Contexts.....	7
Chapter 3. Previous Investigations on Hontoon Island.....	25
Chapter 4. Survey Methods and Results .....	43
Chapter 5. Conclusions and Recommendations.....	71
References Cited .....	75





## **CHAPTER 1 PROJECT OVERVIEW**

The Laboratory of Southeastern Archaeology (LSA) of the Department of Anthropology, University of Florida, conducted a Cultural Resource Assessment Survey (CRAS) at Hontoon Island State Park in March 2009 in advance of proposed infrastructure repair planned by the Florida Department of Environmental Protection (DEP). This research was conducted under 1A-32 permit #0809.056. The survey was performed in accordance with Chapter 267 *Florida Statutes* and all work including background research, field work, artifact analysis and curation, and preparation of this report conformed to Chapter 1A-46, Florida Administrative Code and the Cultural Resource Management Standards and Operation Manual (FDHR 2002).

### **PROJECT DESCRIPTION**

The Hontoon Island Utility Repairs Project #60739, proposed by the DEP, involves repairs and replacement of utilities along approximately 1700 m of existing trails and improved land within the park (Figure 1-1). Hontoon Island State Park is situated in the middle St. Johns River valley, near present-day Deland in Volusia County, Florida. The park is composed of two distinct areas: a parking lot on the north side of the river which is accessed by Ridge Road, and the 400 ha Hontoon Island. In addition to many unimproved areas, the island is characterized by improved land associated with the park headquarters, ranger residences, trails, cabins, houses, and recreational facilities for visitors. These improved areas are clustered in the northern aspect of the island.

The park boundaries are also home to a number of significant archaeological resources. Investigations were initiated there in the late 19<sup>th</sup> century by Jeffries Wyman (1875) and Clarence B. Moore (1894a, b). Except for the documentation of chance finds (Bullen 1955), the park was largely ignored until the 1980s when Barbara Purdy and colleagues targeted wet site deposits on the east side of the Hontoon Island North site (8VO202). Most recently, the University of Florida St. Johns Archaeological Field School spent five field seasons extensively testing extant sites and locating unknown cultural resources across the island (Randall 2007; Randall and Sassaman 2005; Sassaman 2003a). Collectively this research has located 11 prehistoric archaeological sites, a total that includes at least two massive shell mounds and the remnants of a shell ridge and sand burial mound complex. Components of these sites span the Mount Taylor, Orange, St. Johns I and St. Johns II periods, and register nearly 7000 years of repeated, intensive habitation.

#### *Area of Potential Effect*

According to DEP's utility repair proposal, the project will involve a number of activities that could directly impact subsurface archaeological resources within Hontoon Island State Park boundaries (Figure 1-2). The area of potential effect (APE) is a corridor of variable width that ranges from the parking lot, the main landing and headquarters

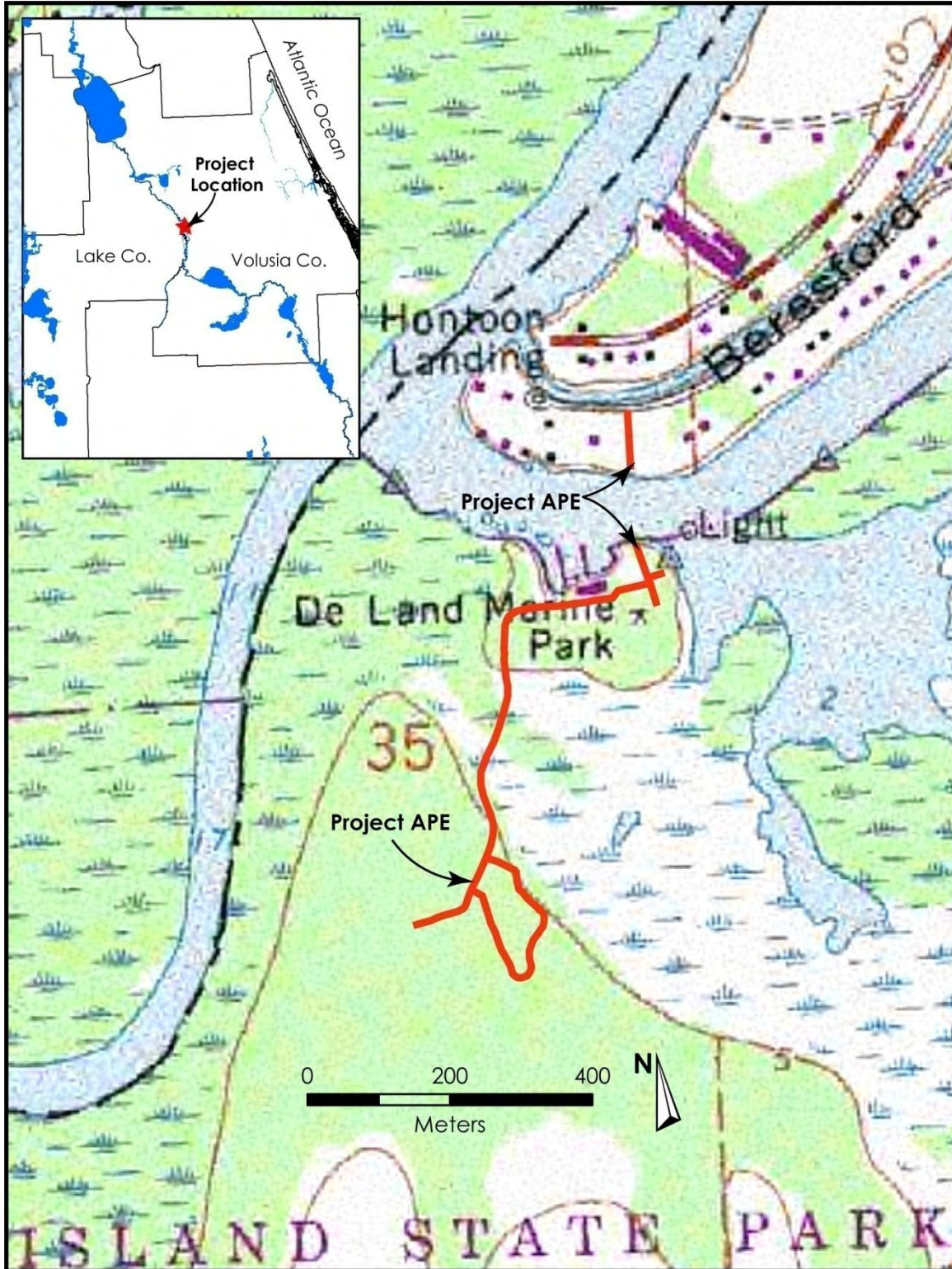

Figure 1-1. Subsection of USGS Orange City topographic quadrangle (1980) showing the location of the project area of potential effect (APE) on Hontoon Island State Park, Volusia County, Florida.

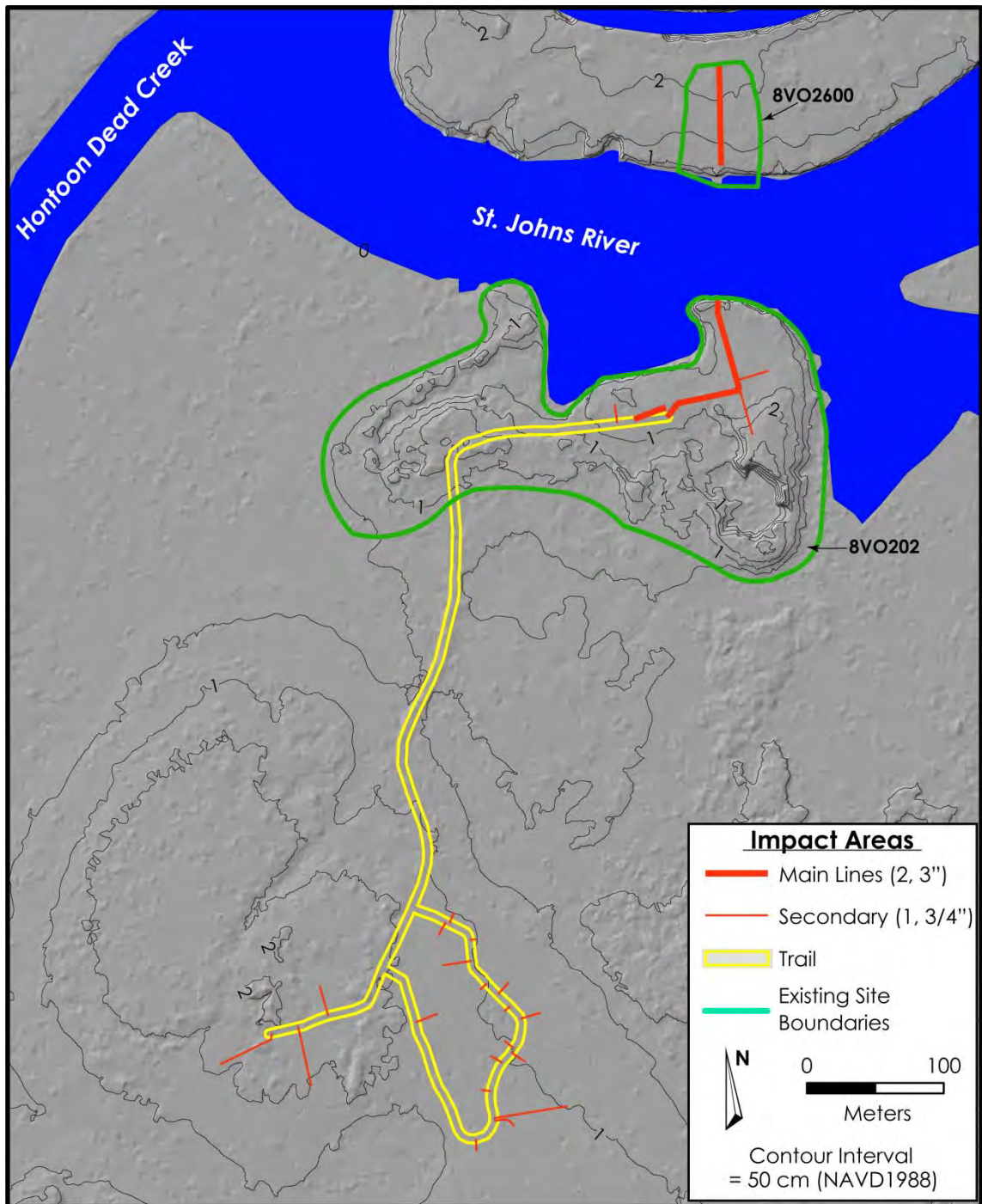

Figure 1-2. Location of proposed impacts from utility repairs on Hontoon Island State Park in relation to known archaeological sites within the APE.

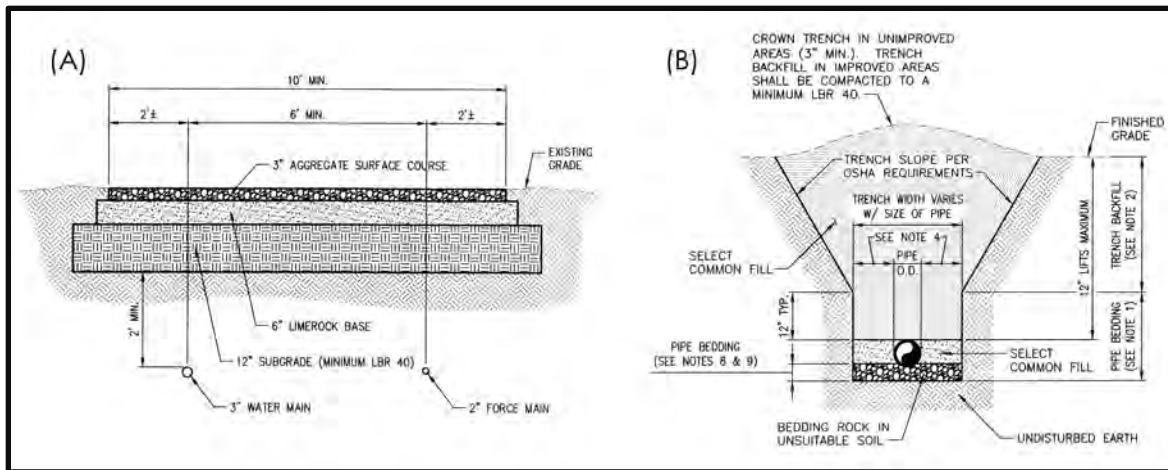

Figure 1-3. Schematic profiles of (A) trail excavation and grading, and (B) trench excavation and utility installation.

area, and the cabins and ranger residences situated south of the landing. Those components of the project that will directly impact subsurface deposits include (a) the replacement of existing water main lines and lateral water service lines to a minimum depth of 36 in (91 cm); (b) replacement or realignment of select force main lines to a minimum depth of 36 in (91 cm); (c) excavation and grading of trail sections to a minimum depth of 21 in (53 cm) with water and sewage lines installed at least 24 in (61 cm) below; and (d) 4-in directional drilling between the parking lot and northeast shore of the island, below the main channel of the St. Johns river. Schematic details for the trail improvement and utility installations are provided in Figure 1-3. Ancillary components of the project that could potentially impact archaeological resources include emplacement of silt fences, construction of earth dikes, offsite tracking maintenance of the construction entrance, topsoil stock piling, and storm water retention measures. A silt fence will be erected around most of the trail segments, and involves the emplacement of rebar stakes at 8 foot (2.43 m) intervals, with the tow of the fabric fence placed 8 in (20 cm) below surface.

The project will affect areas of the park differentially. In the parking lot and along the eastern margin of the main landing, the plan is for existing utilities to be demolished in their current trench, and replaced with new lines. More extensive disturbance will be required for the demolition and replacement of utilities within trail segments. The trail will first be excavated to a minimum depth of 21 in (53 cm) below grade, and then the water main and sewage force main will be installed below the graded bed, spaced at least six feet (1.82) apart from each other, with a minimum two-foot (61 cm) extension on either side of the lines. The implication is that trail segments of the APE could be affected to a depth of 45 inches (1.14 m) in a corridor 10 feet (3.04 m) wide.

*CRAS overview*

Based on a literature review, DEP's proposed utility repairs are situated within the boundaries of two known sites (Figure 1-2). The Hontoon Island North Site (8VO202) is located at the northern end of Hontoon Island, and underlies all improved land in this portion of the project area. In the 19<sup>th</sup> century, site 8VO202 was described as a massive multi-ridge shell and sand mound complex. The current disposition of site 8VO202 reflects a century of land altering practices including shell mining and earth moving for land improvement. Although now heavily disturbed, archaeological research has demonstrated that upwards of 3 m of intact deposits still remain in some portions of the site. These components are known to date from the Preceramic Archaic to the St. Johns II periods (ca. 7000 – 500 BP). The APE within site 8VO202 includes both trail repair and water/force main replacement. The parking lot is the location of site 8VO2600, the Thursby Midden/Hontoon Island Parking Lot site. This site is thought to represent a portion of a large shell ridge and sand mound complex documented by Wyman and C. B. Moore. Although not evident on the surface, intact deposits are thought to be present some 70 cm below surface in portions of the site.

The LSA used a three-component strategy to assess the potential impact of the proposed project. Testing within sites 8VO2600 and 8VO202 was designed to characterize deposits within the APE. Because the boundaries of these sites are well-known, survey methods were implemented to determine the minimum depth below surface of intact archaeological deposits. At 8VO202 this consisted of excavation of shovel test pits (STPs) at 10 m intervals and judgmental augering along the margins of the APE. A total station was used to georeference STP locations with extant geographic data. Our initial plan was to use this same subsurface testing strategy at site 8VO2600, although we were forced to abandon excavation in this locality due to the discovery of unmarked human remains. Outside of known site boundaries, shovel test pits were excavated at 30-m intervals along the trail and select water service line laterals.

As expected, the survey demonstrated that intact archaeological deposits are present across most of the APE within the boundaries of site 8VO202. The LSA identified four "zones of disturbance" based on the depth below surface for intact deposits. Each of these zones has a different potential for being disturbed by the proposed work. The survey within 8VO2600 was limited to a single auger test that yielded human remains. At the request of BAR archaeologists, no further excavation was performed by the LSA within the boundaries of this site. Finally, reconnaissance survey outside of 8VO202 and 8VO2600 did not identify any intact archaeological resources.

## ORGANIZATION OF THE REPORT

The core of this report is organized around the project described above. Chapter 2 provides environmental and prehistoric archaeological contexts for the project at large. Chapter 3 reviews the archaeological research conducted on Hontoon Island to date, with emphasis on sites 8VO202 and 8VO2600. In the following Chapter 4, we elaborate on the survey methods and detail the results of testing. In the final chapter we summarize

the current research conducted at Hontoon Island State Park, and provide recommendations for mitigating the adverse effects of planned infrastructure and trail repairs.

## CHAPTER 2 ENVIRONMENTAL AND ARCHAEOLOGICAL CONTEXTS

This chapter situates the 2009 investigations at Hontoon Island State Park within regional environmental and archaeological contexts. The environment is considered first, focusing in particular on physiography and hydrology. The prehistoric archaeological contexts are then reviewed. In both cases a regional overview is provided, followed by locality-specific discussions.

### ENVIRONMENTAL CONTEXTS

Hontoon Island is located in western Volusia County, approximately 10 km west of Deland (Figure 2-1). The island is situated within the middle St. Johns River floodplain, and is surrounded by the active channel and backwater swamps and streams. At over 400 ha in size, the island is one of the largest in this segment of the river. Hontoon Island's physiography is typical of this segment of the river basin.

The St. Johns River is the dominant influence in the region. The river is in fact a unique and complex fluvial system whose current configuration is the result of a long history of fluctuating sea levels and attendant progradations and regressions of surface waters, localized faulting and solution of carbonate sediments, as well as more recent factors such as channel dredging for navigation. A number of syntheses and cogent discussions of the geology and geomorphology of Florida have been published (Randazzo and Jones 1997; White 1970). In this discussion we focus on those aspects relevant to the middle St. Johns River basin.

#### *Regional physiography*

Like all of Peninsular Florida, the regional physiography of the St. Johns River Valley ultimately owes its configuration to marine processes (Schmidt 1997). Currently, the dry land of Peninsular Florida occupies approximately one-half of the Florida Platform. Extending out into the Gulf of Mexico and Atlantic, the Platform is characterized by low relief, and is composed of Cenozoic carbonate sedimentary lithologies that lie unconformably upon a Paleozoic and metamorphic basement.

The Florida Platform has been alternatively inundated by shallow seas and exposed as dry land during much of the Cenozoic epoch. The low elevation of the Platform (a maximum of 104 meters in the Panhandle) has made it particularly susceptible to relatively small changes in sea level. Sea level fluctuation has resulted in frequent progression and regression of marine, estuarine, and near shore environments. This process has left the Florida coastal zone dominated by positive features including elevated relict upland ridges, barrier beaches, and sand dunes, and negative features representative of shallow seafloors (Schmidt 1997). Terraces that reflect long-term sea level stands have been identified. In the study area these include the Silver Bluff and Palmlico Terraces (0-8 m amsl) and Penholoway and Talbot Terraces (8-21 m amsl).



Figure 2-1. Subsection of USGS Orange City (1980) topographic quadrangle showing location of Hontoon Island.



Additionally, the carbonate composition of many of Florida's sedimentary deposits has been equally influential. Carbonate lithologies are particularly susceptible to dissolution, which results in karst topography and hydrogeology. Typical features of karst topography are sinkholes, sinking rivers, disappearing lakes, and springs (White 1988).

Geomorphologists have recognized a number of physiographic regions defined by topography, surficial geology, and hydrology (Cooke 1939; Schmidt 1997; White 1970). The St. Johns River is located in the Atlantic Coastal Lowlands, a zone typified by coast-parallel features. Most positive features in this region are relict beaches and marine terraces formed during the Late Pleistocene and Holocene, and are composed of siliclastic marine sediments. The headwaters and mouth of the river are situated within the Eastern Valley, while the middle St. Johns occupies a position west of the Crescent City-Deland Ridge. The Crescent City-Deland Ridge is the only karst-dominated topography in the region, and is a major source of groundwater via the Floridan Aquifer.

Groundwater and channeled water hydrology of the St. Johns is linked to precipitation and geology. Ultimately, all of Florida's freshwater is derived from precipitation (Miller 1997). Although a large proportion of precipitation is lost due to evapotranspiration and runoff, a significant amount is returned for the recharge of aquifers. Water levels for most of Florida's streams and lakes are directly related to the aquifer levels. Florida has five principle aquifers, only two of which have output in the middle St. Johns. In general, the study area is typified by an undifferentiated surficial aquifer. Water is typically unconfined in Pleistocene and Holocene sediments averaging 50 feet in thickness, and is present at or just below the ground surface. The Floridan Aquifer is the most extensive and productive of all of Florida's aquifers. It extends throughout the state, in addition to Georgia, Alabama, and South Carolina. Generally, the Floridan aquifer is restricted to carbonate rocks of Tertiary Age, and remains confined well below the ground surface. The aquifer is unconfined or outcrops in regions where these carbonate rocks are thin or have been penetrated by sinkholes. In the study region, the Floridan aquifer discharges along the Crescent City-Deland Ridge principally via first-order magnitude (greater than 100 cubic feet or more per second) springs, including Silver Spring, Silver Glen Springs, and Blue Spring.

As Miller (1998:27) notes, the dominant factor in the study region's landscape is water, which is concentrated along the St. Johns River drainage. The St. Johns River, which has its headwaters in southern Brevard County and discharges into the Atlantic at Jacksonville, is the largest river in Florida, measuring 500 km in length. It is also unique as it is one of few rivers in the northern hemisphere to flow from south to north. Although it is extensive and broad, the St. Johns discharges on average only 8,300 cubic feet per second. The discharge is related primarily to volume and less to velocity. This is due to a wide floodplain and a low gradient (0.02 m per kilometer) (Miller 1998:28). For most of its length, the St. Johns is within five feet of mean sea level. The low gradient makes the river susceptible to small changes in sea level, and even today the river is tidally influenced as far south as the Wekiva River.

The St. Johns River is composed of three distinct segments whose different characteristics relate to a complex geomorphic history (Schmidt 1997; White 1970). Like many of the large river systems in Florida, the St. Johns River is situated in a swale between elevated, upland ridges. Although this configuration was once thought to have formed during late Pleistocene times as a drowned lagoon, it is now believed to have been formed in part within a beach-ridge plain (White 1970) during the early Pleistocene. With the exception of the lower St. Johns, the river is characterized by lakes arrayed in a linear fashion, oriented with the flow of the river. White (1970) suggests that these lakes are sinkholes which have been differentially filled with sediment and linked by channeled surface water.

The upper segment flows between southern Brevard County to Sanford, Florida. This segment is the headwaters, and is characterized by poorly integrated braided streams and extensive wetlands. The middle St. Johns, between Sanford and Lake George, is often referred to as the St. Johns Offset. In a headward-consequent course, the river would be expected to flow from the headwaters to Jacksonville in a relatively straight line following the late Pleistocene beach ridges of the Eastern Valley. However, at Sanford the St. Johns jogs to the west, flowing west of the Crescent City-Deland Ridge. North of Lake George, the river jogs back to the east. It is believed that this portion of the river formed during the early Pleistocene during a period of low sea level, when the offset portion of the river captured the headwaters south of Sanford. The river was eventually integrated when the basin was first inundated, creating an estuary. Subsequent lowering of sea level resulted in the linkage of these segments. The drainage pattern of the middle St. Johns is dominated by an anastomosing pattern, characterized by numerous parallel channel segments. The floodplain is composed of freshwater marshes and swamps. The lower St. Johns is situated between the eastward jog north of Lake George to the mouth at Jacksonville. This course is parallel with Crescent Lake, a relict channel of the St. Johns abandoned when the middle St. Johns switched to its current location. This section of the river is essentially a drowned estuary, and is characterized by a broad channel, averaging over 1 km in width, and inshore marine habitats.

#### *Late Pleistocene and Holocene Environmental Trends*

The same processes that have affected the physiography and hydrology of Florida, namely fluctuating sea level and attendant shifts in climate and environmental regimes, have structured human settlement and their archaeological recognition in the study region. At the end of the Pleistocene sea levels were significantly lower than today (upwards of 40 m), resulting in the extension of inhabitable land over 200 km into the Gulf of Mexico and to a lesser extent the Atlantic (Faught 2004). Between 10,000 and 8000 radiocarbon years before present (rcybp) sea levels initially rose quickly, inundating large expanses of the Florida Platform and interior drainages. Although near-modern levels were gradually achieved by 5000 rcybp (Faught 2004), sea level fluctuated throughout the middle and late Holocene. The increase in sea level and surface water resulted in the inundation of many early sites. Although inundated sites are routinely discovered in low-energy environments such as the Gulf of Mexico and interior sinks and

drainages, many sites along the Atlantic Coast were likely destroyed or deeply buried by transgressing shorelines (Ste. Claire 1990).

The reduction of river gradients in response to sea level change resulted in the initial alluviation and subsequent surface stabilization of interior and coastal fluvial regimes, which in turn affected the flow and biotic characteristics of river channels and floodplains (Schulderein 1996). Peninsular Florida's arid late Pleistocene conditions, characterized by low surface water levels, gradually gave way to a wetter, modern regime ca. 6000-5000 rcybp (Watts et al. 1996). At 10,000 rcybp oak scrub and prairies characterized peninsular Florida. Around 8500 rcybp pine and swamp vegetation expanded from South Carolina throughout much of the Coastal Plain, becoming fully established by 4500 rcybp in southern Florida (Watts et al. 1996:37).

Although the broad characteristics of the middle St. Johns were in place well before humans entered the region, the late Pleistocene and Holocene history of the valley has important consequences for settlement and archaeological recognition. Today, the floodplain is dominated by multiple channels, oxbow cutoffs, lakes, and lagoons. These suggest a complicated history of channel switching, avulsion, and infilling. In part, this variation is related to the shallow gradient of the river and sea level. Based on the distribution of archaeological sites, this hydrologic regime dates to at least 6000 rcybp when the elevation of the river rose to within a meter of present-day levels. However, there were likely significant shifts in the course of the river that would have had effects on the distribution of swamps and wetlands. The presence of archaeological sites hundreds of meters from the main channel, or outside of the range of productive shellfish beds, indicates changes have occurred (Wheeler et al. 2000). More data are necessary to understand the complexity of channel changes through time. More recent changes in the flow characteristics of the river have been wrought during the last 200 years. In addition to the urbanization of the headwaters, the majority of the main channel of the St. Johns has been dredged. Historic documents indicate that the river was first dredged in portions during the 1880s (207<sup>th</sup> House of Representatives, Document no. 1111). During the last century, the river has been fully channelized.

#### *Hontoon Island Physiography, Soils, and Biota*

Hontoon Island is situated mid-way along the middle St. Johns. It is 15 km downstream from the Wekiva River and Lake Monroe, and 15 km upstream from Lake Woodruff. The floodplain in this portion of the river is approximately 4 km wide. With the exclusion of several islands, the floodplain is a low and wide expanse characterized by cypress swamps and grassy marshes at or below 5 feet amsl. Hontoon Island rises only slightly above the floodplain, with maximum elevations near the center of approximately 15 feet. The island encompasses an area of over 400 ha. Approximately half of this area is wetlands, below 5 ft amsl, that are saturated seasonally. The margins of the floodplain are characterized by relatively steep slopes, which to the east rise to elevations between 60 and 85 ft amsl within a kilometer of the channel.

Hontoon Island is surrounded by channeled surface water (Figure 2-1). The active main channel of the St. Johns River forms the eastern and northern boundary of the island. Where the St. Johns river turns to the west, at the apex of the island, lies Lake Beresford. This lake is set off of the main channel, and may represent a relict channel of the St. Johns. The southern boundary of the island is formed by Snake Creek, a narrow and sinuous channel that has its origins just south of Blue Spring, a first-order magnitude spring, at the Snake Creek cutoff. The western boundary of the island is formed by Hontoon Dead Creek, which today is a relict channel of the St. Johns. The channel is visible on aerial and topographic maps as far south as Pine Island and Goat Island. Today the channel is inactive, having been cut off by the current main channel of the St. Johns River. The northern reaches of Hontoon Dead Creek does receives flow north of its confluence with Snake Creek, at the southeastern end of Hontoon Island. In addition to running surface water, there is a large backwater lagoon situated to the east of the northernmost aspect of the island.

Six specific soil units are present on Hontoon Island: Bluff sandy clay loam, EauGallie fine sand, Immokalee sand, Myakka fine sand, Pompano-Placid Complex soils, and Terra Ceia muck (USDA 1980). These soils are generally conformant with major divisions in vegetation, topography, and hydrology. The interior of the island, above 10 ft amsl, is dominated by Myakka fine sand, with an area of Immokalee sand in the southeast, and Pompano-Placid Complex soils in the northernmost interior wetland. Myakka fine sand and Immokalee sand are typical flatwoods soils situated on marine terraces. They are nearly level and poorly drained. During the summer and fall the water table is within 10-12 inches of the surface, and for the rest of the year it is around 40 inches below the surface. Immokalee sand can be submerged for a month or two in years of high rainfall. Primary vegetation in these areas consists of pine-palmetto communities. The overstory consists of slash pine with a scrubby undergrowth of saw palmetto, gallberry, and fetterbush. On Hontoon Island, the interior flatwoods is managed by prescribed burns, resulting in the dominance of low-lying saw palmetto interspersed with slash pine.

Elevations between 10 and 5 ft amsl are characterized by EauGallie fine sand, a nearly level and poorly drained soil. EauGallie is typical of pine flatwoods, consisting of longleaf and slash pine with an understory of saw palmetto, gallberry, and pineland threawn. On Hontoon Island this soil is associated with hammocks consisting of cabbage palm and live oak. A typical EauGallie soil profile consists of an upper horizon of fine sand 21 inches thick that grades from black to gray in color, underlain by an increasingly loamy fine sand that grades from black to dark brown fine sand to a depth of 65 inches. Hydrologically, this soil is characterized by a fluctuating water table which is within 10 inches of the surface for upwards of 4 months a year.

Below elevations of 5 feet amsl, there are spatial variations in the types of soils and vegetation communities present. These differences appear to be related to differential hydrologic histories and configurations. From the northeastern end of the island, extending around to the south and approximately midway along Hontoon Dead Creek the dominant soil is Terra Ceia muck. This is a highly organic black muck which

is very poorly drained and flat. These soils are typically saturated, with the water table at or above the surface for upwards of nine months, and is typically submerged under upwards of two feet of water during the rainy season. On the eastern and southern ends of the island the soil is present in marshlands, dominated by sawgrass and smooth cordgrass. The southwestern aspect of the island at low elevations is a swamp, characterized by swamp hardwoods such as bald cypress, red maple, sweetgum, and loblolly bay.

North of the Hontoon Dead Creek bend, the soils are dominated by Bluff sandy clay loam, a nearly level and very poorly drained soil. This soil is typical of low terraces bordering the St. Johns River. These areas are typically saturated for much of the year, and may be flooded during the end of the summer rainy season. Vegetation consists of water tolerant plants, such as cattails or sawgrass. On Hontoon Island there are hammocks consisting of cabbage palm and live oak throughout, in addition to stands of bald cypress.

The pine flatwoods and hardwood hammocks throughout the interior of the island, as well as the associated uplands to the east of the main channel provide habitat for numerous terrestrial species. Those of economic importance to humans include white-tailed deer, black bear, raccoon, opossum, gopher tortoise, and turkey. In addition, numerous other species of birds, mammals, reptiles, amphibians, and gastropods also inhabit these zones. Although likely not consumed by the islands inhabitants, such species were incorporated into middens through their death or deposition by predators. One species of terrestrial gastropod in particular, *Euglandina rosea* (the rosy wolfsnail), occurs in notable frequency in the basal deposits of some sites on Hontoon Island. The snail is characterized by an elongate shell, upwards of 6 cm in length. *Euglandina* is a carnivorous snail that preys on terrestrial land snails (Cook 1985a, b). Although the significance of *Euglandina*'s presence is unclear, it is likely to occur in greater frequency where other terrestrial snails are present in great numbers, such as disturbed residential areas or stable disposal surfaces.

The extensive wetlands, lagoons, and channel segments provide habitat for a diverse array of aquatic fauna. Aquatic vertebrates such as alligator, otter, turtle, and upwards of 40 species of fish of economic importance to humans are present. In addition, the wetlands are habitat for several mollusks. Species of economic importance to the inhabitants of Hontoon Island include the gastropods *Viviparus georgianus* (banded mystery snail) and *Pomacea paludosa* (Florida apple snail), as well as the freshwater bivalve (Unionidae). Smaller gastropods such as *Elimia* sp. (rasp *Elimia*), and the rams horn and mesa-rams horn (*Planorbella* sp.) can be found with these other species. Unfortunately, little detailed information on the habitat preferences, habit, and seasonal life histories of these species is available. It is unknown in what frequencies these species normally co-occur, or whether there is predictable ecological variation in their availability. In general, all species prefer shallow near-shore environments, such as grassy marshes and shallow lagoons (Quitmyer 2001). *Viviparus* prefer soft, muddy substrates with slack water, such as lagoons, creek edges, lakes, and springs (Clench and Turner 1956). *Pomacea* is known to prefer grassy marshes with at least 50 cm of water.

During dry periods, these gastropods do not aestivate by burrowing into the substrate, and are susceptible to abrupt changes in surface water levels (Darby et al. 2002).

## ARCHAEOLOGICAL CONTEXTS

A number of syntheses of Florida prehistoric archaeological contexts have been issued for the St. Johns Basin (Goggin 1952; Miller 1998; Russo 1990a) and for the state of Florida (Borremans 1990; Milanich 1994; Milanich and Fairbanks 1980; Russo 1990b). These and other locality-specific studies are drawn upon to review the culture history of the middle St. Johns River.

### *Paleoindian (ca. 12,000-10,000 rcybp) and Early Archaic (ca. 10,000-7000 rcybp)*

The late Pleistocene Paleoindian traditions include Clovis, Suwannee-Simpson, and Dalton, which are identified on the basis of diagnostic hafted bifaces. In addition to lanceolate hafted bifaces, the toolkits are characterized by a suite of formal unifaces (Daniel and Wisenbaker 1987), bola stones (Neill 1971), the “Aucilla adze,” and a variety of bone and ivory tools (Dunbar and Webb 1996). Early Holocene traditions dating between ca. 10,000 and 9000 rcybp are identified by Side-Notched and Corner-Notched Bolen points (Bullen 1975). Aside from changes in hafted biface morphology and the addition of new tools, the toolkits of these horizons are consistent with Paleoindian forebears, particularly Dalton.

Today these sites are typically restricted to inundated contexts such as drowned river segments (Dunbar et al. 1988; Faught 2004; Faught and Donoghue 1997), sinkholes (Clausen et al. 1979), or perched basins and depressions (Daniel and Wisenbaker 1987; Neill 1964; Sassaman 2003b). A trend towards increased surface water ca. 10,000 rcybp, and subsequent settlement expansion is attested by Early Archaic diagnostics at Late Paleoindian sites, as well as small numbers of Early Archaic diagnostics in previously uninhabited localities. In general, they are redundant and may represent frequent residential mobility (Milanich 1994). Noting the co-occurrence of Paleoindian artifacts and karst topography in northwest Florida, Dunbar and Waller (1983) posited the “Oasis” hypothesis, that in effect Paleoindian populations were tethered to karst regions, abundant in toolstone and reliable surface water. Although this model matches the general distribution of early components, Paleoindian and Early Archaic diagnostics have been recovered from the St. Johns Basin (see below).

Between 9000 and 7000 rcybp Florida’s Archaic traditions remain poorly defined (Austin 2004; Milanich 1994). Stemmed points, consistent with the Kirk Stemmed type and locally referred to as Kirk, Wacissa, Hamilton, and Arredondo (Bullen 1975) are distributed throughout the North, Central, and Gulf Central portions of the state, often in similar localities as early forms (Milanich 1994). Stratigraphic excavations at Harney Flats (Daniel and Wisenbaker 1987), West Williams (Austin 2004), and Trilisa Pond (Neill 1964) indicate an increase in the diversity of unifacial technology.

This period also witnesses the establishment of a long-standing tradition of pond burials. Individuals were interred in shallow bodies of water such as ponds or sinkhole margins. Windover Pond (ca. 8200-6900 rcybp) in Brevard County represents the earliest and is the most thoroughly investigated pond mortuary in the region (Doran 2002). These sites are typified by large numbers of individuals: 168 were recovered from Windover. Outside of the middle St. Johns pond burials continue into the Middle Archaic.

In general, Paleoindian and Early Archaic sites are underrepresented within the study area (Sassaman et al. 2000). Several factors may account for this, including a lack of adequate toolstone as well as fewer surveys of submerged contexts. In the St. Johns Basin, early sites are expected to occur adjacent to first-magnitude springs fed by the Floridan Aquifer, including Salt Springs, Silver Glen Springs, Juniper Springs, Fern Hammock Springs, Green Cove Springs, Beecher Springs, and Blue Spring (Miller 1998:84). The few known sites and isolated finds that have been documented seem to fit this overall pattern (Sassaman et al. 2000). More recently, a survey of Crescent Lake has demonstrated that there is great potential for recovering early assemblages in the region (Sassaman 2003b). Crescent Lake is a perched water source that was well-watered throughout the late Pleistocene and early Holocene. Collector surveys and near-shore survey of submerged contexts revealed the presence of numerous early diagnostics. There is apparently great potential for submerged early contexts throughout the study area.

*Middle (ca. 7000 - 5000 rcybp) and Late (ca. 5000-2500 rcybp) Archaic*

Several environmental and social trends define the Middle and Late Archaic. In broad terms the Middle and Late Archaic periods are coeval with increasingly wetter conditions of the Middle Holocene, with essentially modern conditions occurring by the end of the Late Archaic. Sites of this period are found throughout much of Florida, and for the first time are located in the interior forests, along the St. Johns River and the Atlantic Coastal Lagoon (Milanich 1994:77). Lifeways predicated on intensive shellfishing are present in the St. Johns by 6000 rcybp and no later than 5600 rcybp on the northeast coast of Florida (Russo 1996). The distribution of sites reflects an overall increase in available surface waters and the exploitation of new habitats, as well as a probable increase in population. By 5000 rcybp regionalization is evident across Florida, as Late Archaic populations expanded into new territories. These new traditions, focused particularly on wetlands, resulted in increasingly larger populations and more permanent settlements (Milanich 1994:87).

Throughout Florida, changes in material culture, including projectile point styles and the appearance of pottery, are used to delineate subperiods and local traditions. In the middle St. Johns several subperiods have been defined, including the Newnan Horizon, the Mount Taylor culture, and the Orange period. Additionally, the "Preceramic Archaic" is a generic term denoting Middle to Late Archaic traditions dated between 7000 and 4200 rcybp which were without pottery technology. Archaeologists typically

assign sites to the Preceramic Archaic when Archaic-age assemblages lacking diagnostic artifacts are recovered.

*Newnan Horizon (7000-5000 rcybp).* Across much of Peninsular Florida researchers have recognized the Newnan Horizon, characterized by short, narrow stemmed, broad bladed chipped stone hafted bifaces (Milanich 1994:76). A number of types have been defined, including Newnan, Marion, and Putnam (Bullen 1975). There is significant variation in the form of stemmed hafted bifaces from this period, leading to a less formal designation of the “Florida Archaic Stemmed” type, which includes any broad-bladed stemmed hafted biface. Lithic artifacts during this period were typically manufactured from thermally altered chert or silicified coral (Ste. Claire 1987). Dates place Newnan sites between 7000 and 5000 rcybp (Milanich 1994:77), although similar forms were likely produced into the Late Archaic.

Settlement in interior Florida, which contains much of the available chert and silicified coral for the production of stone tools, is characterized by a dichotomy between large, diverse assemblages and small lithic scatters. The large sites have been interpreted by Milanich (1994:79) as indicative of reduced seasonal mobility. Austin (2001) suggests, however, that the larger sites likely represent more intensive short-term reduction episodes near raw material outcrops. Several quarries have been identified, including the Senator Edwards site in central Florida (Purdy 1975). Newnan Horizon hafted bifaces are routinely recovered in shell midden contexts along the middle St. Johns. The lack of toolstone in the middle St. Johns precludes their local production. Lithic provenance studies indicate that chipped stone tools were being imported into the region from West and Central Florida (Austin and Estabrook 2000; Endonino 2007).

*Mount Taylor (ca. 6000-4200 rcybp).* The Mount Taylor culture (ca. 6000-4200 rcybp) has been defined to describe the intensive late Middle Archaic and early Late Archaic occupation centered on the extensive wetlands of the middle St. Johns River, the adjacent Ocklawaha and Wekiva rivers, and associated Atlantic Coastal Lagoon (Goggin 1952; Wheeler et al. 2000). This is an archaeological construct, and it refers to a suite of site types and diagnostic artifacts. Many of the lifeways set in motion during this period, including subsistence practices and site selection, continued through European contact. Although the broad details of lifeways are known for this period, the Mount Taylor culture remains poorly understood for several reasons. Mount Taylor period components are typically buried deeply under later components or submerged under alluvium or peat deposits. Moreover, many sites of this period have been destroyed or impacted by modern land-use practices. The majority of shell mounds appear to have been mined in part or whole for road fill during the middle of the 20th century (Milanich 1994).

Settlement patterns during this period are not well known (Wheeler et al. 2000). Seasonality studies of late Middle Archaic sites in the coastal Timucuan Preserve (Russo et al. 1993) suggest that these areas likely had well-established patterns of movement within these localities. Although this does not preclude movement either within the middle St. Johns, or to the Atlantic coast or interior, it does suggest that populations were relatively circumscribed. Based on botanical remains and hydrology, Grove’s Orange



Midden has been interpreted as being occupied multiseasonally (Russo et al. 1992). It is presumed that the large middens throughout the middle St. Johns represent multiseasonal to permanent year-round base camps that articulate with smaller task and season-specific localities (Wheeler et al. 2000).

Mount Taylor sites are present throughout the middle St. Johns Basin (Sassaman et al. 2000). Although sites are located adjacent to the main channel of the St. Johns, many are situated adjacent or within low-lying swamps or marshes. Wheeler et al. (2000) suggest that there are several general configurations, including ovoid midden-mounds, ridges of shell, complexes of shell fields, ridges, and mounds in addition to small, diffuse middens. The configuration of Mount Taylor occupations is made less clear in multicomponent sites, where Mount Taylor assemblages are partially or completely obscured by later deposits (Wheeler et al. 2000).

It is unclear how most Mount Taylor sites are internally organized, and whether there were specific areas for habitation, refuse disposal, or other tasks. To date, no evidence for habitation structures has been identified. Along with the occasional post-mold, features that have been recorded at large sites such as the Lake Monroe Outlet Midden (8VO53) (Archaeological Consultants and Janus Research 2001) and Fort Florida (8VO48) (Johnson 2005) tend to be large shell-filled basins. Further evidence comes from the Lake Monroe Outlet midden, where lithic reduction tasks were apparently segregated from domestic refuse or processing tasks (Scudder 2001). Stratigraphically, Mount Taylor middens are characterized by shell midden lenses, typically composed of whole and crushed *Viviparus*, *Pomacea*, and bivalve. Strata can be composed of a mixture of these taxa, or as concentrations of a single taxa. In many cases individual strata are composed of a single taxa, which may be burned, whole, or crushed. Another feature of Mount Taylor sites is the presence of concreted midden (Wheeler et al. 2000), which can occur either as thick, extensive lenses or as localized conglomerates. It has been suggested that concreted midden is formed by the interaction of ash, shell, and percolating water.

In addition to basal deposits of concreted midden, Mount Taylor sites typically contain saturated or submerged components up to a meter in thickness that appear to have been inundated after formation. Due to the cost and time involved in dewatering and excavating saturated deposits, these have only rarely been investigated. Wet site investigations of Mount Taylor age are limited to Groves' Orange Midden (8VO2601), a Mount Taylor and Orange period site on the eastern shore of Lake Monroe where archaeological deposits extend over 30 m into the lake (McGee and Wheeler 1994). The site is a segment of the much larger multicomponent Old Enterprise mound and shell field complex (8VO55). Stratigraphic excavations yielded five discrete strata. The earliest primary deposition (Stratum IV) dates roughly between 6000 and 5000 rcybp and is characterized by dense *Viviparus* midden. These early dates are supported by a date from 6200 rcybp from the base of Live Oak Mound (Sassaman 2003a), indicating that the establishment of wetland habitat and its exploitation by residents of the middle St. Johns occurred by at least 6200 rcybp, if not before. At Grove's Orange midden, this basal stratum underlies a thick peat deposit (Stratum III) which dates 5000 and 4300 rcybp

(McGee and Wheeler 1994). This peat is thought to represent a seasonal marsh, which suggests a high water stand. Rare artifacts within this stratum attest to shifts in refuse disposal that likely relate to micro-environmental changes. Above this peat deposit is another dense *Viviparus* midden, dated between 4300 and 4100. These data not only demonstrate the variability in surface waters through time, but also suggest that much of the early record of the Preceramic Archaic lifeways is likely submerged beneath Florida's lakes and rivers.

Ceremonialism was well developed in Mount Taylor culture, as evidenced by the construction of ceremonial shell mounds. Although traditionally viewed as relatively late-period constructions or the result of mundane activities (Milanich 1994), a consideration of early observations by Jeffries Wyman (1875) and C.B. Moore (1999), and more recent excavations at Bluffton (8VO22) and Mount Taylor (8VO19) mounds, (Wheeler et al. 2000) the Harris Creek site (8VO24) on Tick Island (Aten 1999), Live Oak Mound (8VO41) (Sassaman 2003a), and the Tomoka Mound complex (8VO81) (Piatek 1994) on the Tomoka River demonstrate that many mounds were deliberately constructed during Mount Taylor times. Although Mount Taylor burials have been recorded in only a few cases (Endonino 2003a), similarities in the form and internal structure of these mounds indicates that many if not all were mortuaries.

Although only eight mounds have been archaeological tested in modern times (Bluffton, Mount Taylor, Harris Creek, Live Oak, Tomoka, Hontoon Dead Creek, Thornhill Lake, and Silver Glen Run), many more likely existed prior to their destruction during the 20<sup>th</sup> century. That many of the mounds contained Preceramic deposits was well documented by Jeffries Wyman (1875). Wyman, then curator of Harvard's Peabody Museum, made extensive collections and observations of shell-bearing sites throughout the middle St. Johns River between 1860 and 1873. Through pedestrian surveys and collections, observations of cut-banks, and small excavations, Wyman recorded over 40 ridges, ridge complexes, and conical mounds throughout the basin. Later in the 19<sup>th</sup> century, C.B. Moore (1999) revisited many of these sites. His more intensive excavations provide both a confirmation of the Preceramic origins of many mounds, as well as documented the stratigraphic sequences and mortuary nature of these sites.

Most mounds share similar external configurations and internal sequences (Endonino 2003a; Wheeler et al. 2000). Although they vary in size, Mount Taylor mounds appear to be of two different shapes. Many mounds are crescent-shaped ridges, with steeply sloping sides and asymmetrical summit mounts 5 to 11 m tall. Others, such as Bluffton and the Thornhill Lake mounds (8VO58) are round, truncated cones. Some of this variation may be due in part to later occupations above the Mount Taylor components. With some variations, a routine sequence has been identified. Where the cores of these mounds have been documented they typically have a basal shell layer. In the case of Bluffton this layer was intentionally burned (Wheeler et al. 2000). Small earthen mounds of allocthonous white sand or muck were then constructed on this midden. Burials were then placed into these deposit. In the case of Bluffton there was only a single interment, while at Harris Creek over 140 burials were interred over a period of time. Although grave goods are rare in some contexts (Aten 1999), some

individuals such as at Thornhill Lake were interred with exotic artifacts. Subsequent to interment, the earthen mound was capped with shell, which in some cases was clearly excavated from preexisting midden deposits (Aten 1999; Piatek 1994). These capping episodes appear to have been repeated, possibly during major ceremonies or festivals (Sassaman 2003a).

The importance of wetlands is evident not only in the placement of sites, but in the subsistence remains. Mount Taylor lifeways were characterized by fishing-hunting-subsistence economy. Faunal analysis at Grove's Orange Midden (Russo et al. 1992; Wheeler and McGee 1994), Lake Monroe Outlet Midden (Quitmyer 2001), and Blue Spring Midden B (8VO43) (Sassaman 2003a) demonstrate the dominance of aquatic species, which could have been acquired from marshes, slackwater lagoons, and sloughs. Although it was once thought that shellfish contributed a small percentage of the diet, recent studies indicate that between 33 and 98 percent of the dietary meat weight was derived from freshwater shellfish. Studies have shown that shellfish diversity varies with site contexts, and may reflect local ecological variations (Quitmyer 2001). A diverse array of fish were collected, including catfishes, sunfish (*Lepomis sp.*), gar (*Lepisosteus sp.*), largemouth bass (*Micropterus salmoides*), and eel. Turtle was also collected, including such species as the soft shelled turtle (*Apalone ferox*), sliders, and mud/musk turtles.

Where waterlogged conditions have enabled the preservation of plant matter, such as at Groves Orange Midden (Newsom 1994; Russo et al. 1992) and Windover Pond (Newsom 2002) a stable pattern characterized by high diversity is established by no later than 8000 rcybp. Pulpy fruits such as black gum, prickly pear, saw palmetto, maypop, wild plum, blackberry, persimmon, red mulberry, elderberry and grape appear to have been the most important (Newsom 2002). These fruits were supplemented with starchy seeds such as amaranth, pigweed, and knotweed, as well as the greens from these and other species. Numerous tubers were potentially eaten. Cabbage palm hearts and shelf fungi have also been identified (Newsom 2002).

Mount Taylor period assemblages are typified by mundane and decorative material culture manufactured from locally available bone, fired clay, and wood, in addition to exotic materials (Wheeler et al. 2000). Bones from deer and other terrestrial animals were used to make a variety of tools including gouges, awls, needles, fids, projectile points, and decorative pins. Wooden tools have been recovered from saturated deposits such as Groves' Orange Midden (Wheeler and McGee 1994) and include tool handles and net floats. Fired clay objects of various shapes and sizes have also been recovered from numerous contexts.

Nonlocal materials used to manufacture tools and items of adornment speak to the extensive trade networks in which Mount Taylor groups were engaged. Marine shell demonstrates contact or movement to coastal regions. Shell tool assemblages are dominated by woodworking tools, including *Busycon sp.* axes and adzes, as well as celts made from *Strombus gigas* shell. Marine shell was also used to make containers, which are often recovered with residue adhering to the interior surfaces, as well as awls and net mesh gauges. Decorative shell artifacts are also typical, and include marine shell beads

and plummetts made from large whelk columella, as well as decorative shells such as *Oliva sp.* Shark teeth are often recovered. Many have been drilled to facilitate hafting for use as a tool or as personal adornment. Contact with the interior and west coast is demonstrated by the presence of lithics. There is no source for raw material for chipped stone tools in the St. Johns basin, and many artifacts appear to have been traded into the region in whole and finished forms. Hafted bifaces are consistent with those of the Newnan horizon. Aside from hafted bifaces, Mount Taylor lithic assemblages are dominated by unifacial tools that appear to have been used for a wide range of applications including perforating, scraping, and cutting (Archaeological Consultants and Janus Research 2001).

The presence of ground stone beads and bannerstones provides evidence for contacts farther afield. Groundstone beads have been recovered from several mortuary and cache contexts, (Thornhill Lake mounds 1 and 2 [Moore 1999] and Coontie Island respectively (Clausen 1964)). Although their origins are unknown, they are quite similar to tubular beads produced in Mississippi and the Mid-south during the Middle Archaic. Bannerstones have been recovered from several mound contexts, including Thornhill Lake, Tomoka Stone, and Coontie Island. The forms are consistent in form and raw material with those manufactured in the Middle Savannah River in Georgia and South Carolina (Sassaman 2004; Sassaman and Randall 2007).

*Orange (4200-3500 rcybp) and Early St. Johns (3500-2500 rcybp).* The appearance of pottery in shell middens of the St. Johns River and Atlantic Coastal Lagoon signals the end of the Preceramic traditions and the beginning of the pottery producing traditions. Orange tradition fiber-tempered pottery has been dated as early as 4200 rcybp in the lower St. Johns, although pottery does not appear in the middle St. Johns until 200 years later (Sassaman 2003c). By 3500 rcybp fiber-tempered pottery ceases to be manufactured, signaling the end of the Orange period, and is wholly replaced by spiculate-pasted wares. Once thought to be diagnostic of the St. Johns period, radiocarbon dates (Sassaman 2003c) and paste characterization studies (Cordell 2004) demonstrate that spiculate pottery was produced as early as 4000 rcybp and continued through the end of the Late Archaic and into the St. Johns Period.

Orange period lifeways have been portrayed as continuing the basic trends set in motion during the preceding Preceramic. Excluding the production of pottery, and new hafted biface types such as the Culbreath, Lafayette, Clay and Levy types (Milanich 1994), continuity is suggested by the continued use of marine shell and stone tools, although marine shell does appear in reduced frequency at some sites. As evidenced by subsistence data from Blue Spring Midden B (Sassaman 2003a) and Grove's Orange Midden (Russo et al. 1992), populations continued to exploit aquatic habitats (Quitmyer 2001; Russo et al. 1993; Russo et al. 1992), routinely collecting from local shellfish beds, and capturing fish and turtles.

The economic importance of wetlands is further demonstrated by the continued focus of settlement adjacent to the river. Milanich (1994:86-87) asserts that differences in Orange site distributions reflect changes in demography and not basic lifeways.

Orange sites are most likely to be found along productive wetlands and marshes, often in the same locales as earlier Preceramic components, while there is a decrease in sites in the interior forests of northern Florida. The more numerous and larger Orange components may very well reflect an overall increase in population. This observation, however, must be tempered by the fact that Preceramic components may not be adequately recorded due to inundation, stratigraphic ambiguity, or a lack of diagnostic artifacts.

Although there certainly is significant continuity, divergence in traditions within the St. Johns is clearly evident during Orange times (Sassaman 2004). The upper St. Johns is characterized by smaller sites that taken as a whole system constitute year-long settlement (Sigler-Eisenberg et al. 1985). In the lower St. Johns large, presumably multi-seasonal middens are surrounded by smaller probable fish-processing stations (Russo 1993). In addition to these habitation areas, large shell rings have been identified both at the mouth of the St. Johns and along the coast (Russo and Heide 2002; Russo et al. 2002). These sites were likely accretionally but intentionally constructed, and were the loci of communal feasting and ritual activities (Russo 2004; Saunders 2004).

Settlement in the middle St. Johns has been less well documented, but it appears to replicate Mount Taylor site types, characterized by a division between extensive middens, mound complexes with abundant pottery, and small task sites. Because these sites have not been routinely investigated, data on their internal organization and function are scarce. Sassaman (2003c) has identified a possible Orange period semi-circular compound at Blue Spring Midden B. The compound was situated above a Mount Taylor midden and adjacent to a Mount Taylor mound. Three households and their associated refuse piles were identified. Although seasonality data have not been forthcoming, the site was repeatedly reoccupied, and potentially permanently settled. Extensive Orange pottery assemblages have been recovered from mound complexes such as Bluffton, Harris Creek on Tick Island, and Old Enterprise. It is not clear, however, whether Orange communities in the middle St. Johns actively mounded shell as their coastal neighbors did. At Bluffton the pottery was deposited adjacent to and not on top of the mound (Wheeler et al 2000). In excavations at Live Oak Mound, Sassaman (2003c) recovered only a small number of sherds, all from near the surface. This validates the observations of Wyman, who rarely observed thick deposits of pottery-bearing shell midden. While ceremonial activities likely occurred in these places that were sacred to Mount Taylor communities, there is no clear evidence that Orange communities continued the tradition of mound building in the middle St. Johns.

Orange fiber-tempered pottery has been viewed typically as a chronological marker. Bullen (1972) constructed five subperiods, based on changes in vessel construction and surface decoration. The unilineal sequence consisted of a transition from Orange Plain to incised (Orange Incised and Tick Island) wares, which were eventually replaced by spiculate-tempered St. Johns Incised vessels. However, radiocarbon dates have shown that variation in tempering agents, vessel form, and surface treatment likely reflect spatial variation in the production and use of pottery (Cordell 2004; Sassaman 2004), not temporal trends as once thought. That is, periods 1-3 are

coeval, and must be explained in terms of spatial patterns (Sassaman 2003c). Sassaman (2004) suggests that village sites such as Blue Spring Midden B are dominated by plain pottery that was rarely used over fires, while large and complex sites such as Harris Creek and Silver Glen Run are dominated by incised vessels that were routinely used over fire. He suggests, as Saunders (2004) does for the coastal Orange shell rings, that the different distribution likely represents different social contexts, where plain pottery was used in mundane contexts, and incised pottery was used primarily during ceremony and communal feasts.

The recent upheaval in the chronology and typology of fiber- and spiculate-tempered wares has left an approximately 1000 year gap between the Orange and St. Johns I periods. A “Transitional” period was defined by Bullen as a bridge between primarily fiber-tempered assemblages and incised spiculate-tempered wares (Milanich 1994:88). Isolating sites of this period has remained problematic (Miller 1998:76), likely because many of the wares thought to occur after the Orange period are actually coeval. Although the term “Transitional” should be discarded, there is a need to document sites of this period. An early date of 3500 rcybp on a spiculate-tempered assemblage at the Joseph Reed Shell Ring (8MT13) in southern Florida (Russo and Heide 2002) indicates that this interval will likely be populated with components as more dates are acquired.

#### *St. Johns (ca. 2500-500 rcybp)*

Although St. Johns pottery dates as early as 4000 rcybp, fully developed St. Johns culture begins around 2500 rcybp and continues into European contact. The archaeological culture was defined by Goggin (1952), who used changes in pottery styles to identify subperiods. The St. Johns I (ca. 2500-1250 rcybp), is typified by plain “chalky” spiculate-tempered wares, and the St. Johns II (ca. 1250-500 rcybp), typified by plain and check-stamped varieties. These ceramic types are formally referred to as St. Johns Plain and St. Johns Check Stamped, respectively. Additional subperiods have been identified by the presence of foreign wares or local copies of them, as well as changes in mortuary ritual (Milanich 1994:247): St. Johns I (2500-1900 rcybp), Ia (1900-1500 rcybp), Ib (1500-1250 rcybp), IIa (1250-950 rcybp), IIb (950-487 rcybp [A.D. 1050-1513]), and IIc (A.D. 1513-1565). As Miller (1998:79) notes, however, these divisions are not easily traced because the diagnostic artifacts or sites are rare.

Although there are clearly numerous changes in social organization, material culture, and ceremonialism that were incorporated from external contacts, the St. Johns period is actually marked by conservatism (Miller 1998:78). Along the St. Johns River, St. Johns I and to a certain extent St. Johns II lifeways continued seemingly unchanged “from that of their late Archaic, Orange-period predecessors” (Milanich 1994:254). In part this is due to the overall similarity in environments through time, as essentially modern conditions were established by the end of the Orange period. Regional studies indicate that St. Johns I components are likely to be found on sites with Orange components, and this trend continues with a similar frequency of reoccupation for St. Johns II components (Miller 1998; Sassaman et al. 2000). Year-round villages, short-term task sites, and large ceremonial mounds are present throughout St. Johns River and

its tributaries, and along the coastal lagoons from Jacksonville into Brevard County. Although equally distributed on the coast and along the St. Johns, St. Johns period sites are also located in interriverine localities. Increases in population from Orange to St. Johns II times are suggested by increases in sites per century. Unfortunately, village contexts have rarely been excavated, so it is unknown how large the residential populations of each these places may have been.

Continuity with Orange period subsistence practices is also evident. Coastal assemblages are dominated by oyster and coquina, in addition to estuarine fishes (Milanich 1994: 257). Subsistence data from the St. Johns period wet site deposits at 8VO202 on Hontoon Island indicate that populations continued to focus on the collection of aquatic resources, such as gar, catfish, largemouth bass, alligator, and turtle, in addition to *Viviparus* and bivalve (Wing and McKean 1987). A wide array of plants were also exploited, including many that were collected during the preceding Archaic (Newsom 1987). Cultigens that supported large populations and complex forms of social organization elsewhere in the Southeast occur in relatively limited frequencies. Bottle gourd (*Langeria siceria*) seeds and rind fragments and *Cucurbita pepo* gourd fragments were recovered in St. Johns II contexts, although these were likely used for containers or net floaters. Maize, a staple throughout much of the Southeast by St. Johns IIB times, was present in historic contexts only. Although cultivation or encouraged gardening may have been practiced, it does not appear to have been widespread or intensive in the middle St. Johns.

Changes in material culture throughout St. Johns I and II times were primarily restricted to pottery decoration and hafted biface types (Milanich 1994:247, 263). Hafted bifaces were typically small and crude, and include the Jackson, Florida Copena, Bradford, Columbia, Broward, Taylor, Westo, Florida Adena, Gadsen, Sarasota, and Ocala types (Bullen 1975). Plain St. Johns wares dominate St. Johns I components. Locally produced Dunns Creek Red vessels were produced during Ia and Ib times, while during Ia copies of Deptford and Swift Creek and during Ib Weeden Island vessels were produced. These often were deposited in mortuary contexts. At A.D. 750, potters began to apply check-stamped designs with wooden paddles. During IIa times, late Weeden Island pottery and copies were made, while elements of the Southeastern Ceremonial Complex are evident in IIB assemblages. During St. Johns IIa or IIB times, there is a shift to the use of small hafted bifaces such as Pinellas, Ichetucknee, and Tampa points. Other tools found in St. Johns period assemblages were shell adzes, celts, picks and hammers. Bone tools include a variety of awls, pins, pendants, and beads.

While subsistence and technology remain relatively unchanged, ceremonial and political life clearly changed in relation to external contacts (Goggin 1952; Milanich 1994:260-262). Mounds of the St. Johns I period were low, truncated cones constructed of sand. Bundle burials, extended interments, and cremations were placed into the mound. Many mounds were reused for multiple interments, which may indicate that interred individuals were members of the same lineage, as in Weeden Island mounds. During the St. Johns Ia period, larger mounds were constructed, and exotic items such as galena and copper were interred, along with locally made St. Johns Plain and Dunns

Creek Red pottery. Towards the end of Ia, Hopewell influences are evident in the construction of log tombs. Mounds of Ib age show evidence for Weeden Island influences. St. Johns IIa mortuary practices appear similar to earlier practices in that they continue to be used for multiple, likely kin-based burials (Milanich 1994:268).

Beginning with the St. Johns IIb subperiod, the construction of mounds takes on a different character, and is clearly influenced by Mississippian cultures to the north and west. Although it is unknown precisely what level of social organization was present at this time period, the symbolism and quantity of material culture is similar to chiefly societies elsewhere in the Southeast at this time. At least three large pyramidal mounds were present in the middle St. Johns basin, including Shields, Mt. Royal, and the Thursby Mound located across the St. Johns channel from Hontoon Island. These sites were large earthen works, likely constructed in stages. C.B. Moore (1999) excavated all of these sites, and recovered caches of copper, galena, silver and gold, *Busycon* shells, greenstone celts, and clay vessels and effigies in addition to scattered or poorly preserved human remains. The silver and gold attest to these sites being occupied into the European contact era (Milanich 1994).



### **CHAPTER 3**

#### **PREVIOUS INVESTIGATIONS ON HONTOON ISLAND STATE PARK**

This chapter presents a literature review of previous investigations on Hontoon Island State Park. We focus on work conducted at the sites most likely to be impacted within the APE. Portions of this discussion have been adapted from chapters of LSA technical reports (Randall and Hallman 2005; Randall and Wallis 2007; Sassaman et al. 2005).

#### **HONTOON ISLAND CULTURAL RESOURCE INVENTORY**

No historic archaeological sites have been identified within the park boundaries. It is generally asserted that prior to 1967, when the Park was acquired by the State, the island had been the location of cattle grazing, a homestead, and a cannery. The cannery is present in a historic photograph, and was located on the northeastern point of the island. No traces of this or other structures are evident today.

In contrast, a total of 11 prehistoric archaeological sites have been identified within the confines of Hontoon Island State Park (Figure 3-1). Ten of these sites are situated on the island, including a shell ridge (8VO214), a multi-ridge shell mound complex (8VO202), seven shell fields (8VO215, 8VO216, 8VO7493, 8VO7494, 8VO8312, 8VO8313, 8VO8314), and a lithic scatter (8VO8315). Four sites have been recorded in the vicinity of the parking lot on the Beresford peninsula, but only site 8VO2600 has been documented within the park boundaries. Site 8VO238 is a wet-site find, while sites 8VO35, 8VO36, and 8VO2600 are components of the Thursby Mound/Midden complex that was composed a large shell ridge and sand mound. Sites 8VO35 and 8VO36 have “General Vicinity” locations, while 8VO2600 is well documented within the parking lot.

The cultural resource inventory reflects nearly a century and a half of archaeological observations. Prior to 2000, no systematic survey had been conducted on Hontoon Island. In the late 1800s, Jeffries Wyman (1875) observed two shell mounds and two shell “fields” on the perimeter of the island. Soon afterward, C.B. Moore (1999) was refused access to the island, but excavated and reported on the Thursby mound complex just to the north of Hontoon Island. During the early 1980s, Bruce Nodine and Ray McGee performed a surface survey of the island concurrent with excavations at site 8VO202. They located two shell-bearing sites, one on the eastern margin and one to the south. These were denoted on a map of Hontoon Island published by Purdy (1991:Figure 35). No Florida Master Site File (FMSF) survey log was filed, and no details of these investigations were published. Site 8VO2600 was identified after a bulldozer operator exposed and removed portions of the parking lot in 1989, and is thought to represent a basal component of the Thursby complex excavated by Moore. The discovery and subsequent monitoring of this project was detailed in correspondence to DHR and curated within the FMSF.

Systematic reconnaissance of the island was conducted between 2000 and 2005 by the University of Florida St. Johns Archaeological Field School. Between 2000 and



Figure 3-1. Previously recorded sites on Hontoon Island State Park property (Orange City [1980] USGS topographic quadrangle).

2001 reconnaissance focused on testing site-discovery transects, relocating sites documented in the FMSF, and refining the boundaries of known sites (Endonino 2003b). Four site-discovery transects were tested across the interior of the island, with one intersecting an interior wetland. No sites were located in the interior of the island, and two sites were located on the west and east margins (sites 8VO7493 and 8VO7494, respectively). The field school also relocated two previously documented sites. The Hontoon Dead Creek Village site (8VO215) was provisionally bounded. Two transects were tested along the southern margin of site 8VO202, resulting in an expansion of known deposits.

The results of this prior work were the basis for a shift in survey strategies during the 2003-2005 St. Johns Archaeological Field School seasons (Randall 2007; Randall and Sassaman 2005). Based on the distribution of known archaeological sites and random transects, several patterns became evident. The four transects excavated across the island suggested that the probability of locating sites in the interior is low, although a full-coverage survey would be required to verify this pattern, particularly around interior wetlands. In contrast, all known sites were adjacent to wetlands around the perimeter of the island. These surveys indicated that there was great potential for discovering archaeological deposits along the margins of the island. On this basis, the field school conducted a testing program between 2003 and 2005 that targeted the intersection of the wetlands and upland slopes along the periphery of the island. This area roughly approximates the 5 foot contour interval on the Orange City USGS topographic quadrangle (Figure 3-1). Survey along contiguous transects on the eastern, southern, north-central, and western aspects of Hontoon Island identified four sites (8VO8312, 8VO8313, 8VO314, 8VO8315), relocated site 8VO216, and expanded the boundaries of site 8VO7493. All terrestrial components of sites except for 8VO7493, 8VO8312, and 8VO8315 were bounded with negative shovel tests.

Repeated surveys on Hontoon Island indicate that shell bearing sites are clustered along the margins of the landform. This pattern in part reflects the intensity of survey conducted in these zones. Thus, it is possible that smaller sites without surface exposure may be present within the APE, particularly at the intersection of the wetland south of 8VO202 and the campground and ranger residence areas.

#### HONTOON ISLAND NORTH (8VO202)

Hontoon Island North was investigated by Jeffries Wyman (1875), and visited but not excavated by Clarence B. Moore (1893, 1894) in the 1890s. The site was mined for shell in 1935, removing upwards of 6 m of surface shell. Before becoming a State Park in 1967, the northeast point held a cannery facility. Archaeological research was renewed during wet-site deposit investigations by Barbara Purdy (1987, 1991:102-138) on several occasions in the 1980s. The 2001 St. Johns Archaeological Field School conducted limited shovel testing at the site (Endonino 2003b) in advance of more extensive work in 2003 and 2004 that included augering, additional shovel tests, and stratigraphic test excavations (Sassaman et al. 2005).

The locations of all known archaeological excavations, park improvements, and the project APE within 8VO202 are provided in Figure 3-2. In the following discussions, this map will be referred to in locational descriptions. However, it is worthwhile to briefly outline the physical characteristics of the site today. Situated at the north end of Hontoon Island, the area within the boundaries of 8VO202 has been significantly altered after the site was mined, and particularly since the park was created in 1967. This section of the park has a semi-elliptical shape today, not including the harbor in the center of the site. Topographically, 8VO202 is characterized by a wide and flat area to the north and east. In contrast, areas to the south and west contain large pits and trenches. As we detail below, these features are the result of shell mining in the 1930s. Most park improvements are situated in the area fronting the river and on the eastern point. The harbor area consists of docks for the Park ferry and for visiting boats. The river-facing perimeter of the island is reinforced with concrete block revetment to prevent erosion. Park improvements include a ranger station at the docks, and a bathhouse to the southeast at the highest point of the site. Recreational facilities are clustered on the eastern point, and include a swing set, playground, pavilion, and several grill stations.

*Jeffries Wyman and C. B. Moore*

In his 1860s expeditions to the St. Johns River valley, Jeffries Wyman (1875:28-30) described the original configuration of a massive ridge-and-mound complex at the north end of Hontoon Island. He notes that the St. Johns River at this spot passed through two sets of mounds, the one to north known as Thursby Mound (and later excavated by Moore [see below]), and the one to the south, on the island, consisting of two shell ridges and two conical mounds. The shell ridge fronting the river on the south side was estimated by Wyman to be 600 feet long and 12-14 feet high. The river had already eroded the length of this ridge, leaving the sheer, cut-bank profile that appears in a photo published by Moore (1894).

To the rear (landward and south) side of this first ridge Wyman observed a second, larger ridge. A “deep valley” separated the two parallel ridges (Wyman 1875:28) by about 100 feet. The eastern end of the rear ridge was at least 25 feet tall when Wyman observed it. No further details about the size and shape of this feature can be inferred from his short account, but Wyman does add that two conical mounds of sand and shell were located to the “rear of the eastern end of the inner ridge,” the larger of the two estimated at 25 feet in height. Wyman dug a five-foot-deep hole at the apex of the smaller mound, and a trench 4 to 6-feet wide, 2 to 4-feet deep, was dug up the side of the larger mound to its apex. Fragmented human bone and pottery sherds were found in the upper two feet of his excavations. Only *Viviparus* and *Pomacea* shell was observed in deeper mound fill. Although he apparently did not uncover articulated human remains, Wyman speculated that both conical mounds were probably burial mounds.

Shell mining in the 1930s has erased most of the features that Wyman observed, although surviving elements of the “inner ridge” provide a glimpse into the size and orientation of at least part of this complex (see section on mapping below). Using Wyman’s descriptions and extant ridge remnants as points of reference, Ray McGee was

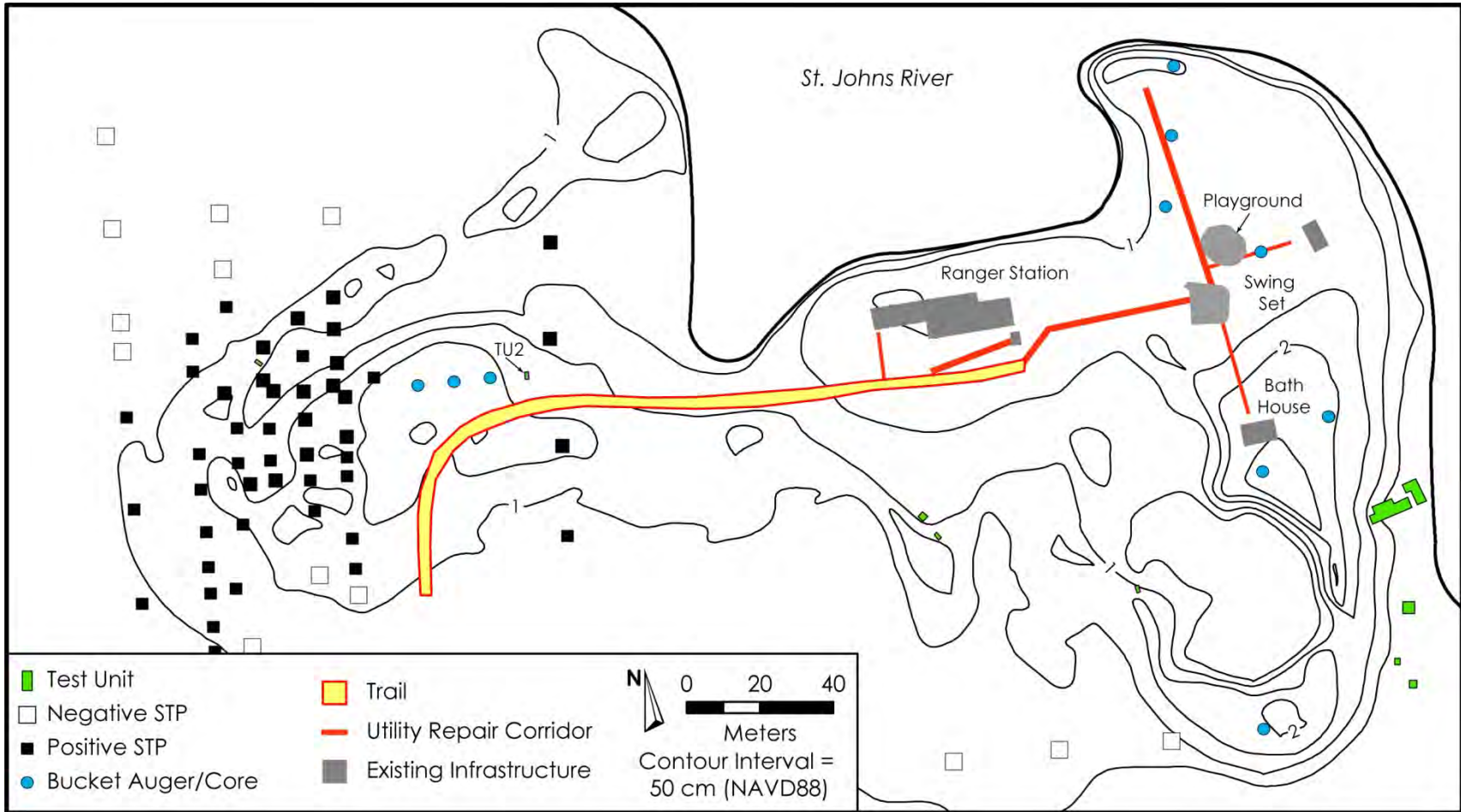

Figure 3-2. Location of previous archaeological work at the Hontoon Island North Site (8VO202) in relation to the project APE.

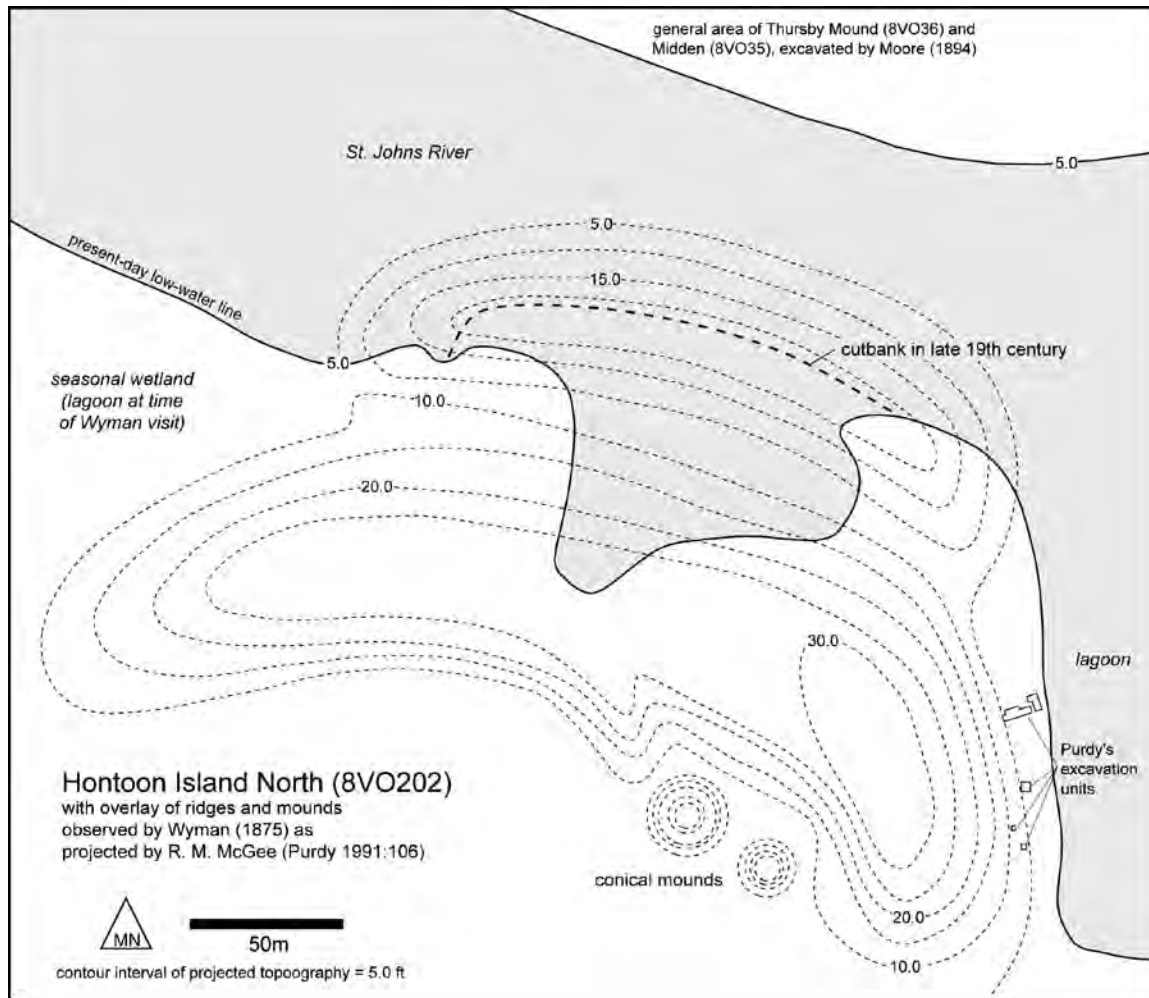

Figure 3-3. McGee's Projection of the ridge-and-mound complex described by Wyman (1875), showing locations of present-day low-water lines, the Thursby Mound (8VO36) and Midden (8VO35) across the river, Purdy's excavation units, and the probable late-19<sup>th</sup> century cutbank observed by Moore.

able to project the probable configuration of the entire complex onto the modern land surface (Purdy 1991:106). A modified version of McGee's projection is provided in Figure 3-3. McGee's projection suggests that about one-third of the plan area of the site was destroyed by mining and river erosion. The north or "outer" ridge would have originally extended farther into the modern channel of the St. Johns River, where Moore observed a cutbank at least 12 feet high. The ranger station location would have been under the center of inner ridge, as would the current trail heading to the west and south. The area of water-line installation in the recreation area to the east would have been adjacent to or within the valley. Finally, the bathhouse to the southeast would have been near the apex of the inner ridge.

*Purdy's Expeditions*

Over seven periods of field work in the 1980s, Barbara Purdy and colleagues from the University of Florida delved into the saturated deposits along the edge of the inner ridge that remained after shell-mining operations in the 1930s removed most of the shell-and-ridge complex. Most of her research focused on areas outside of the APE. However, her work does provide some insight into the structure of deposits near the bathhouse. Shell mining presumably began with the removal of the cutbank along the outer ridge, and then proceeded to the inner ridge from an access point that now serves as the harbor for the park. Mining of the inner ridge was much more complete along the eastern aspect, location of the apex, than along the western aspect, where concreted midden and areas of limited shell may have discouraged further excavation (see below). An apron of intact ridge enclosing the deep mining pit at the eastern end of the inner ridge was the focus of Purdy's work. Fronting water to the east, this portion of intact ridge trailed off into the lagoon and provided an opportunity for the recovery of organic deposits with remarkable preservation.

Evidence for exceptional organic preservation in the waters surrounding Hontoon Island had already been established before Purdy's work commenced. In 1955 a dragline operator pulled a 12-foot-long wood carving of an owl from the St. Johns River channel fronting the Thursby midden (8VO35) (Bullen 1955). In this same location two smaller carvings of an otter and a pelican (Purdy 1991:110) were recovered during a drought in 1977 and assigned site file number 8VO238. These discoveries prompted a cultural resources inventory of Hontoon Island a year later (Dunbar et al. 1978), and an evaluation of its wet-site potential as part of a state-wide survey of wet sites two years later (Purdy 1991:106).

Purdy's work on the near-shore saturated deposits of Hontoon Island North began in 1980 with a 3 x 3-m unit near the base of the remnant of the inner ridge. The stratigraphic sequence of this unit consisted of a 50-cm thick overburden of culturally sterile organic matter overlying a 10-cm thick shell-free midden with early historic artifacts of European manufacture, followed by 30-60 cm of freshwater mussel midden and 60+ cm of freshwater snail midden over sterile, basal sand (Purdy 1991:107). A second unit was excavated in 1982, this one 2 x 2-m, followed by a major trenching operation in 1984 with a field school crew. A 2-m wide trench with a 6-m long lateral extension began on the terrestrial portion of the ridge slope and continued into the lagoon some 16 m. A footpath separated the terrestrial and lagoonal portions of this discontinuous trench (Purdy 1987:9). Another 4-m extension of the trench into the lagoon was made in 1985, and a final extension into the lagoon in 1988 with a two-month *Earthwatch* project (Purdy 1991:108). The terrestrial portion of the 1982 trench was backfilled after excavation, but the portions located in the lagoon remain open to this day. The sequence observed in the 1980 unit was generally duplicated in Purdy's other units, with the upper organic zone expanding in thickness out in the lagoon, and the upper two zones missing in units on the terrestrial portion of the ridge slope, where the shell strata thickened.

A series of radiocarbon and thermoluminescent assays were obtained on samples taken from columns to establish an (uncalibrated) age range of ca. 740 B.C. to A.D. 1850 for the wet deposits, with most of the dates falling in the latter half of this span (Purdy 1987:11). The basal snail midden returned age estimates clustering in the range of A.D. 900-1350 and contained thousands of St. Johns II sherds and preserved organic remains. Age estimates for the overlying mussel midden and the shell-free midden above it fall in the sixteenth century A.D. and thus postdate European contact. The presence of early Spanish artifacts in this upper stratum corroborated the radiometric age estimates. These deposits were roughly coeval with the Thursby mound across the river, which likewise contained items of early European contact. A single test unit some 40-m west of the trench in the area of mined shell provided evidence for a Preceramic component at Hontoon Island North (Purdy 1987:12), although details about this unit and its content are not reported. A comparable Preceramic component was not encountered in the lagoon.

Based on these investigations, it is likely that the majority of deposits along the eastern aspect of the inner ridge, including the remnant apex near the bath house, are post-Archaic in age, and date to the St. Johns I or II periods. Moreover, these deposits are likely intact, despite some near-surface disturbances resulting from shell-mining.

#### *St. Johns Archaeological Field School*

Between 2000 and 2004, the University of Florida St. Johns Archaeological Field School conducted four seasons of investigations at 8VO202. The goal was to characterize the distribution of deposits across the site and detail the origins of habitation there. Efforts included topographic mapping, shovel testing, limited augering, and stratigraphic excavations. Because of the extensive nature of the work conducted, this research is critical for understanding the disposition of deposits within and adjacent to the APE. Topographic mapping, augering and shovel testing, and excavation of Test Unit 2 near the road all provide details relevant to the current cultural resource assessment.

*Topographic Mapping.* As seen in the contour map (Figure 3-2), the surface remnants of site 8VO202 are visible to the south and west of the recreation area and ranger station. As noted above, shell mining likely removed the smaller outer ridge. The deep valleys and escarpments in these areas represent remaining portions of the site left by shell mining activities. In contrast, the north and eastern aspects of the site are characterized by open and relatively flat surfaces. The eastern aspect of this ridge is well defined by the large mining pit, which, we presume, was centered on the apex of the ridge and thus provided miners the greatest return on their efforts. Much of the western portion of the inner ridge was apparently left intact, especially in the area just to the northwest of the southward bend in the dirt road. Topography to the immediate north slopes downward in a linear feature oriented southwest-northeast of this intact area, marking, it would appear, a mining trench that followed dense shell but was terminated due to concreted midden and less dense shell to the south.

This dome-like area between the trail and the mining trench was intensively shovel tested, augered, and examined with a single test unit (TU2), which intercepted



human skeletal remains and was thereby terminated. This western remnant of the inner ridge may contain a Mount Taylor period mortuary feature similar to the one Bullen salvaged at Harris Creek on Tick Island (Aten 1999). No surface traces exist for the two conical mounds described by Wyman southeast of the inner ridge. Wyman notes that the cores of each of these features consisted of shell so we presume that they were completely leveled in the mining operation. Access points to the projected location of these features are not apparent in the extant topography, and subsurface testing to date has been insufficient to determine if the base of these mounds survived.

*Subsurface Reconnaissance.* Large-scale characterization of subsurface deposits of Hontoon Island North was accomplished through a combination of standard shovel tests and bucket augers. In areas with shell deposits exceeding 1.0 m in depth—notably the eastern end of the inner ridge near the mining pit and the peninsula to its north—bucket augers were sunk to examine strata as much as 3 m deep. Close-interval shovel testing targeted the western periphery and mined escarpments.

Four-inch-diameter bucket augers were sunk in seven locations to characterize surviving portions of the shell ridges in the eastern portion of the site (Figure 3-2). Bucket augers can be used effectively to characterize gross stratigraphic relationships, such as abrupt changes in midden composition, the base of shell deposits, buried A horizons, and the like. Augering commenced judgmentally with a test (Core 1) at the topographic high of the site, just to the north of the mining pit and 10 meters south of the bathhouse shown in Figure 3-2. Incapable of reaching the base of shell deposits in this locale, the crew proceeded to a lower elevation 21 m to the northeast (Core 2), where the water table was encountered at a depth of 2.2 m BS, and shell midden continued below but was too loose and too saturated to be extracted. A third auger (Core 3), 45 m to the north of Core 2 encountered a vastly different profile consisting mostly of sandy clay matrix with minimal shell. A series of three additional augers (Core Point 1-3), following the point of the peninsula to the north, finally succeeded in reaching the base of the shell deposit after penetrating over 3 m of stratified shell deposits with pottery. A final auger (Core 4) on the south rim of the mining pit revealed at least 2.4 m of shell deposits extending into the water table. These augers generally follow the existing APE corridor.

These seven auger tests form something of a north-south transect that we profile in Figure 3-4 along with the extant surface topography and projections of Wyman's ridges. Added to this cross-section is the profile of Test Unit 1. Each of these eight profiles is graphed in Figure 3-4 at their actual elevation relative to the scale provided and in a horizontal position true to scale of the extant surface topography shown in cross-section. These few auger tests provide limited perspective on what obviously are highly complex and varied stratigraphic sequences in the eastern portions of 8VO202. Nevertheless, some observations are highly significant and seemingly reliable. First, the remnant of inner ridge surrounding the mining pit, and adjacent to the APE terminus at the bath house, is intact and at least its upper meter consists of St. Johns-era deposits. Although downward displacement of sherds in augers is a constant risk in interpreting stratigraphy, the occurrence of multiple St. Johns sherds along the full depth of Core 2 corroborates the sequence Purdy observed in the lagoon. The lack of pottery in the lower

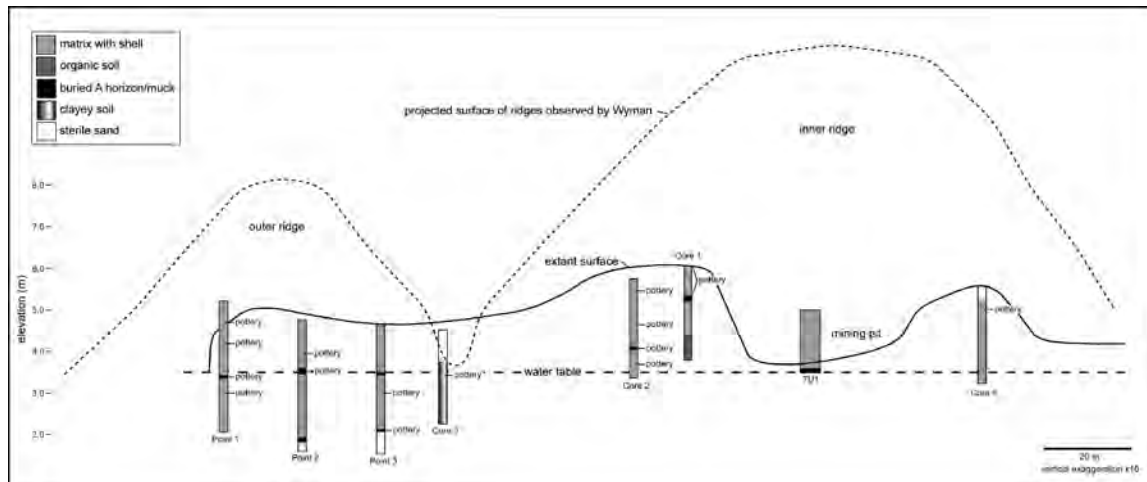

Figure 3-4. Schematic cross-section of the eastern end of Hontoon Island North (8VO202), showing topography of extant surface, the projection of ridges observed by Wyman, the water table, and generalized profiles of bucket augers and Test Unit 1. Elevations relative to arbitrary site datum established at 5.0 m.

reaches of Cores 1 and 4 may signal the presence of Preceramic deposits, although the usual cautions about small sample size and negative evidence apply here.

The second significant finding from augering was that the remnant of the outer ridge surviving shell mining appears to consist exclusively of pottery-era deposits and these exist well below the current water table. Two of the augers in this area (Point 2 and 3) penetrated archaeological deposits to reach sterile sands 1.3 to 1.6 m below the water table. If the buried A horizon at the top of sterile sands correlates to the buried A seen in TU1, then some of the midden accumulating at the base of the outer ridge may predate the St. Johns era. Buried A horizons or muck layers were recorded in all three “point” augers at the elevation of the current water table, but it is unlikely that these correlate to the buried A horizon of TU1 because below them are upwards of 2 m of shell-bearing deposits with occasional St. Johns sherds. Finally, Core 3, located to the landward side of the outer ridge, produced a unique sequence of largely clayey matrix with minimal to moderate amounts of mostly crushed shell. This is close to the projected location of the “valley” observed by Wyman between the two ridges. The profile of this core is consistent with the formation of sediments in standing water that occasionally experienced low-energy erosion from runoff and possibly channel cut-through during high-water (flood) episodes. Again, the small window of observation afforded by bucket augering is insufficient to accurately characterize these deposits, but they truly differ from all other profiles. Furthermore, the upper 50-60 cm of this core appears to consist of mixed and contorted sediment that was likely deposited during the mining operation and subsequent land leveling.

Shovel testing in 2003 was designed to finalize the boundaries of Hontoon Island North and provide observations on subsurface deposits to assist in siting test units for stratigraphic excavations. Most of the shovel testing at 8VO202 was concentrated in the

western end of the site where the lowest aspect of the inner ridge appears to have survived shell mining (Figure 3-5). Few artifacts were recovered here, but excluding an occasional sherd, results of testing indicate that this western aspect dates principally to the Mount Taylor period. The locations of shovel tests in this area are provided in Figure 3-2. Running in an east-west direction across the bottom of this map are shovel tests of a transect excavated in 2000 to define site boundaries. Three additional transects (T2, T3, and T4) were excavated in 2003 on a perpendicular axis to locate the north and south boundaries of this western aspect. The westernmost transect (T3) consisted of three positive tests with vertebrate fauna and shell sandwiched between several negative tests, the latter situated in both areas to the north and south. Apparently sterile subsoil was reached at about 70 cm BS in two of the three positive shovel tests (T3-STP6, STP7); concreted shell was encountered in the third positive test (T3-STP4) at 58 cm BS. All of the negative shovel tests north of the positive tests of Transect 3 intercepted groundwater some 30-50 cm BS.

One-hundred meters to the east, Transect 2 consisted of several positive shovel tests containing shell, much of it concreted, and vertebrate fauna, along with one negative test south of the 2000 transect. None of the Transect 2 shovel tests encountered sterile subsoil. Equidistant between Transects 2 and 3, Transect 4 consisted of nine positive shovel tests with shell, vertebrate fauna and occasional artifacts, terminated on either end by negative tests. Seemingly sterile subsoil was reached in T4-STP8 at 95 cm BS, and in T4-STP11 at 79 cm BS. All other positive tests terminated at concreted midden from 52 to 94 cm BS. Additional transects running north-south were oriented between Transects 3 and 4 to examine the area most severely impacted by mining operations. Concreted midden was consistently encountered at depths less than 90 cm BS, and none of the tests reached conclusively sterile subsoil. Several of the tests in this intervening area produced artifacts, and all contained vertebrate fauna, occasionally in abundance.

Given the evidence at hand, it appears that the dome-like topographic feature in this area (bordered on the west by Transect 4 and on the east by Transect 2) occupies a natural rise in the terrain, estimated at ca. 50 cm above the water table. Concreted midden was encountered on both sides of this dome-like feature, as well as along the scarp of the mining trench that forms its northwest boundary. Most of the shell tools and lithic artifacts came from shovel tests on either side and at the terminus of this trench. Insofar as all these shell-bearing deposits date to the Mount Taylor period, the dome-like feature that was spared shell mining must likewise date no later than the Mount Taylor period. What remains uncertain is the extent to which this dome-like feature is anthropogenic. As we discuss in the section below on Test Unit 2, the possibility remains that this feature consists of a mortuary facility similar to the Mount Taylor mortuaries documented at the Harris Creek site (Aten 1999).

The results of previous subsurface testing in the vicinity of the APE at 8VO202 have implications for the current project. Along the eastern section, which today houses the bath house and playground, archaeological deposits with integrity are expected to exist either at or near the contemporary surface. Near-surface deposits of the St. Johns

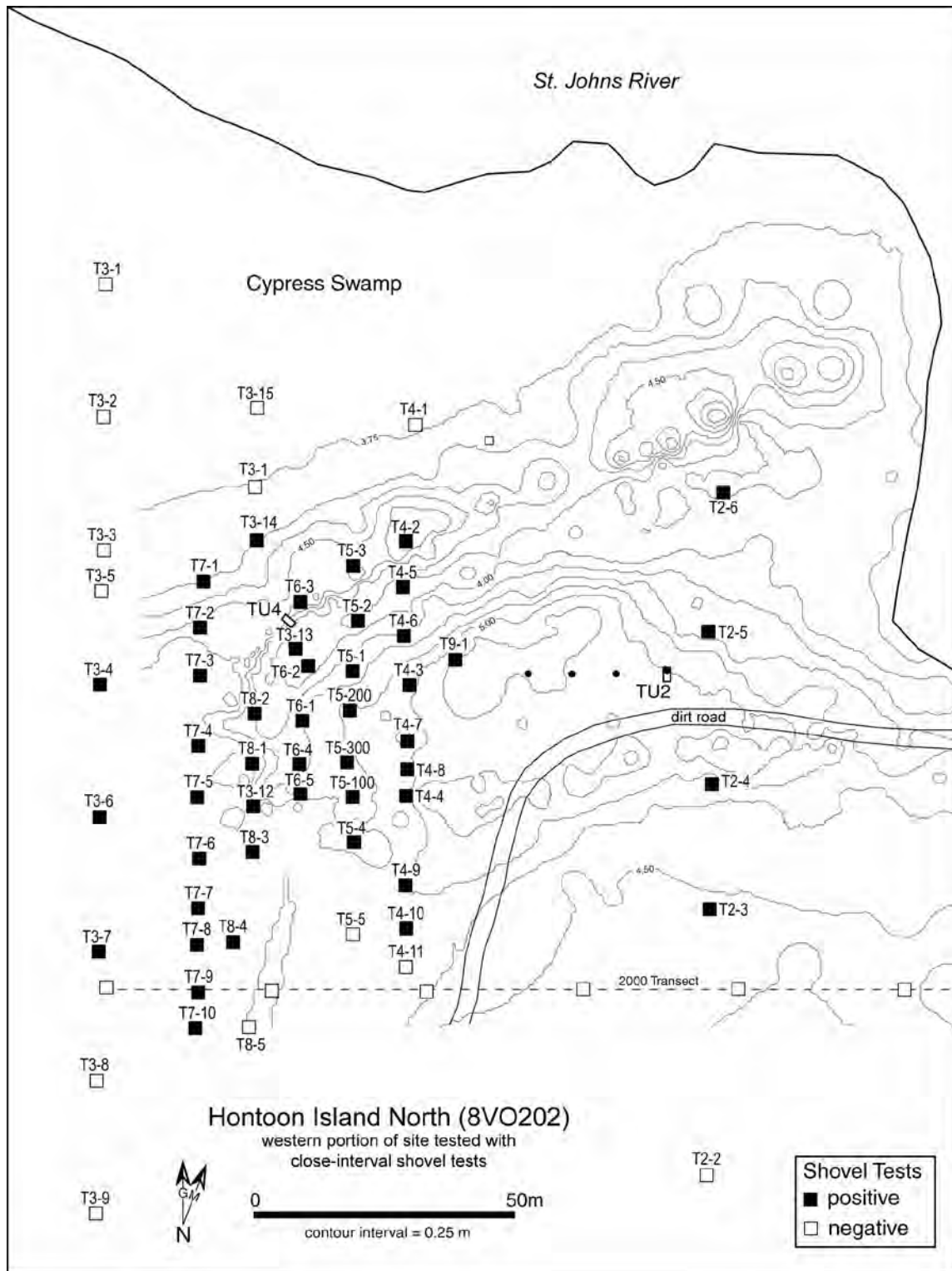

Figure 3-5. Topographic map of western portion of Hontoon Island North, showing locations of all shovel tests excavated in this area. Elevations relative to arbitrary site datum established at 5.0 m.

era are likely in the vicinity of the bath house. Where the property flattens out to the north, deposits surviving mining are likely within 60 cm of the surface. Augering encountered complex stratigraphy in this region, so it is possible that further testing will reveal a highly intercalated surface contact between mining surfaces and post-mining fill. Shovel tests in the western aspect of the site, where the road bends to the south, are also illuminating. In general, concreted shell midden was encountered near the surface in STPs near the APE corridor. Because concreted midden is nearly impenetrable, the depth of intact deposits below surface is generally unknown. However, it is likely the persistent presence of concreted midden is the result of mining operations that ceased because of the difficulty of midden extraction. Thus, these near-surface deposits are likely intact and of Preceramic Archaic age.

*Test Unit 2 Excavation.* A final aspect of the Field School's findings has relevance here. As described above, many of the western shovel tests were placed in a somewhat linear mining trench fronting the northwest perimeter of the inner shell ridge, where chunks of concreted shell midden were strewn about the surface and exposed in profiles. Apparent Preceramic deposits were also found in a high area roughly 50 x 50 m in extent, just to the south of the western mining pit. Test Unit 2 was placed at the eastern edge of this area of higher ground, between two tests of a north-south shovel-test transect that uncovered apparent Preceramic deposits (Figure 3-2). The results of this unit suggest that the dome-like feature that dominates the western edge of the site may have served as a Preceramic mortuary.

Near-surface strata within TU2 consisted of a post-mining surface and an intact non-mortuary component. The surface strata of a thin humic layer over a grayish-brown sandy matrix with moderate amounts of crushed and whole freshwater shell, predominately *Viviparus* and bivalves, along with traces of *Pomacea*. A few small St. Johns plain sherds and chert flakes were recovered, along with trace evidence of modern refuse (bottle cap, glass), and occasional vertebrate fauna of apparent prehistoric age. This upper stratum assumed a relatively sharp contact with underlying midden, suggesting it was redeposited over a truncated surface from shell mining. This surface stratum continued into Level B (10-20 cm BS), particularly in the north half of the test unit. Revealed first in the south half of the unit, and eventually exposed across the unit, was an underlying dark, organic stratum of fine silty sand midden with moderate amounts of shell and pockets of concretion (Stratum II). This deposit varied in thickness from only a few centimeters to as much as 23 cm. Pottery was not recovered from any fill of this stratum, but vertebrate faunal remains increased markedly over Stratum I.

At approximately 30 cm BS, this especially dark midden transitioned into a somewhat lighter-colored midden (Stratum III) with low to moderate shell frequency, including occasional whole *Pomacea*. Again, pottery was not recovered in any of the fill removed and screened from this stratum. The first traces of human remains came in the form of isolated teeth, one each in the upper stratum of TU2 and in the shovel test immediately northeast of TU2. Because the upper stratum of TU2 also contained traces of modern refuse and had the appearance of secondary deposition, we did not consider these isolated teeth to be in primary context. Other possible fragments of human bone

were likewise found amongst the vertebrate remains of Strata I and II in TU2, but none of these fragmentary and often concreted elements were definitively human. Unequivocal human remains were first exposed in TU2 at ca. 40 cm BS in the south half of the unit. A decidedly human clavicle and other probable human remains were exposed in the undifferentiated matrix of Stratum III. These elements were exposed sufficiently to establish a positive human identification and to check for a possible pit outline. Excavation was otherwise halted at this point to record these observations and then backfill the unit.

Limited subsurface testing in and around TU2 was conducted with the aid of a 4-inch bucket auger to delineate the depth and extent of the unusual strata in this elevated portion of the site. Each of the three auger tests to the west of TU2 contained both the organic midden with limited shell, as well as deeper concretion in lighter-colored, sandy or silty matrix. The depth of the basal concreted midden conformed to the surface topography. None of these additional cores included the surface midden and thin underlying organic horizon observed in profiles in TU2. Given the relatively lower topographic position of TU2, as well as its proximity to both the dirt road and the mining pit escarpment, these upper strata may very well have been redeposited after an episode of erosion or land alteration. Given the unusual stratigraphic sequence of the area surrounding TU2, human skeletal remains may be associated with a specialized mortuary feature, such as the basal, Preceramic component of Harris Creek (Aten 1999).

Excavations of TU2, while limited, indicate that the APE near the dome could contain further mortuary evidence within the specified depth of disturbance due to road grading and utility installation. To be sure, the LSA's work in 2003 shows that mounded shell and associated midden in the central and eastern portions of the shell ridge do not contain human remains, although the scale of excavation to this point is admittedly very small. In contrast, the human bone exposed in TU2, near the west end of the shell ridge, is situated in distinctive strata, dominated by organic sediment, rather than shell. What is more, it lies in an area that is topographically superior to surrounding terrain and rife with concreted midden. The relief of this area is owed in large measure to the limited amount of shell mining, which, one might suggest, was due to the combination of concretion and low shell density. In any event, it seems reasonable to suggest that the area surrounding TU2 is stratigraphically distinct from all other tested contexts at 8VO202, and thus may very well consist of a macrofeature whose functions included the interment of human remains.

#### THURSBY MOUND COMPLEX (8VO2600)

The FMSF places the Thursby Mound Complex along the northern border of the main channel of the St. Johns directly opposite of the Hontoon Island North site. Three distinct localities are currently plotted on this landform, including site 8VO35 (Thursby Midden), 8VO36 (Thursby Mound), and 8VO2600 (Thursby Midden/Hontoon Island Parking Lot). Sites 8VO35 and 8VO36 have "General Vicinity" (GV) location accuracy, while site 8VO2600 has normal location accuracy. Although the specific location of the

entire complex is unknown, at least a portion of it does reside within the confines of the APE within the Hontoon Island Parking lot (Figure 3-1).

*Jeffries Wyman and C. B. Moore*

Like 8VO202, Wyman and Moore provide crucial details on the location, structure, and contents of the Thursby Mound Complex. In this case, however, Wyman only provides passing mention while Moore actually excavated a portion of the site. Wyman (1875:29) identified a shell ridge and sand mound complex on the north side of the St. Johns river channel, directly opposite to the Hontoon Island North site. He described it as composed of a linear shell ridge, approximately 6 feet high and as long as the outer ridge at 8VO202 (roughly 600 feet). He indicated that behind the ridge, to the north, was a shell field and a shell mound that measured 14 feet high and between 30 and 40 feet in diameter. At the time of observation, the shell ridge fronting the river had been heavily eroded.

C. B. Moore excavated the sand mound portion (8VO36) of the complex during the winter of 1892-93 (1894a:64-82) and nine days in 1894 (1894b:158-167). He (1894a:64) describes the mound as being located opposite the shell bluff of Hontoon Island, where: “50 yards from the water it is hidden from view by oaks and palmettos....a causeway of shell connects it with a shell ridge bordering the river....The mound is very symmetrical. Its height above the surrounding level is 11 feet, its circumference 300 feet, its form the usual truncated cone.” This description conforms generally with Wyman’s, and indicates that the sand mound was situated only 150 feet from the main channel, which could have placed the mound within the parking lot. Because he focused his excavations on the sand mound proper, there are scant details on the associated shell ridge. However, he does note that shell midden was underlying the southern and western ends of the mound, where shell could be seen eroding into the river. The shell was nearly flat underneath the sand mound. He noted a number of burials throughout the various sand and shell strata which were used to construct the mound. Burials were superficial as well, and all European objects were in the upper portion of the mound. He also located now-famous effigy pottery, apparently in a large pit near the surface. He continued excavations in 1894, and reports that “the mound was completely demolished” (Moore 1894b:158).

*Salvage*

The site was all but forgotten until the end of the 20<sup>th</sup> century. In 1989, Hontoon Island State Park was given a dredge-and-fill permit to dredge the nearby river and harbor. As part of this project, a holding pond was excavated into the underlying shell midden within the parking lot boundaries. The excavated shell midden was used to construct a four-sided berm that acted as a dike to contain spoil materials prior to removal. A reconstruction of the results of this process is provided in Figure 3-6. In a letter dated May 9, 1989, Ray McGee describes how “the center of the parking lot had been bulldozed to form the walls of the holding pond...It appears that about 80% of the

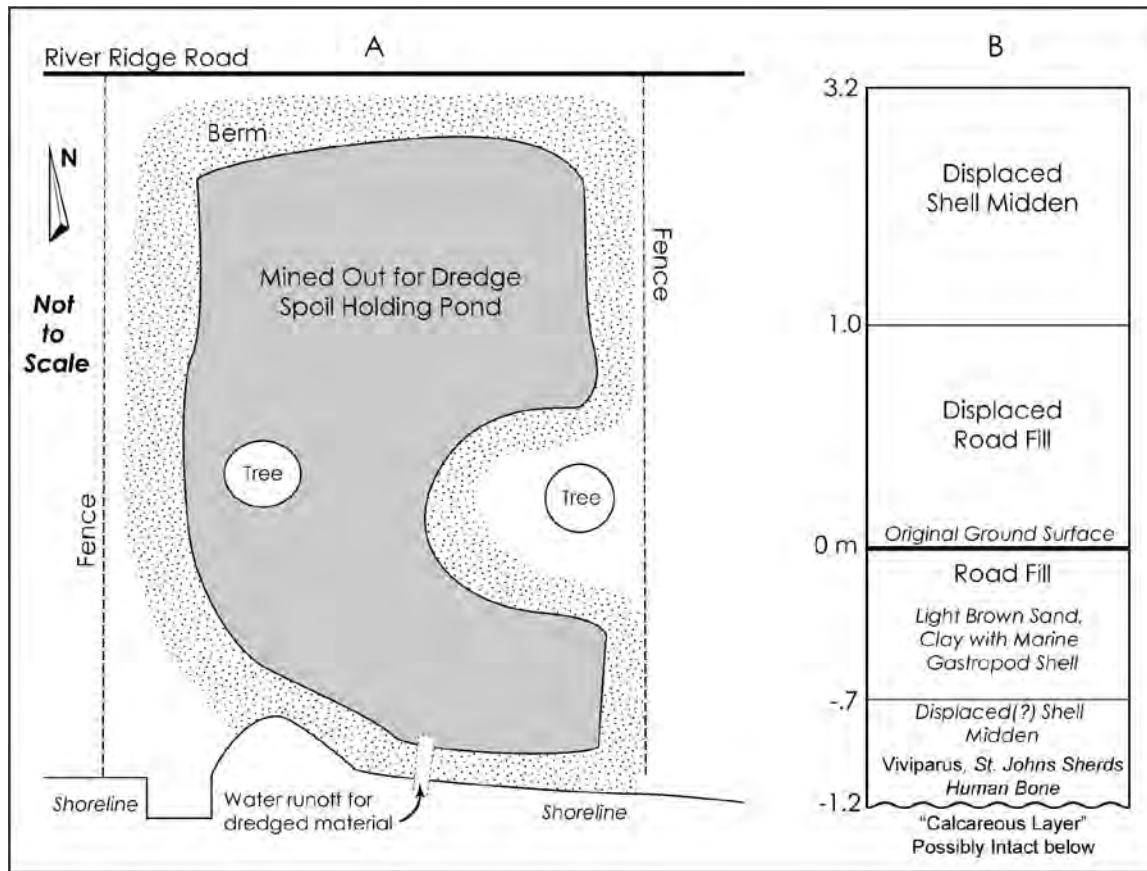

Figure 3-6. Area of disturbance at site 8VO2600, the Thursby Midden/Hontoon Island Parking Lot: (A) Sketch map of dredge spoil pond excavated in center of site, redrawn from Groh's Map #4 in letter to BAR, (B) exposed profile of eastern berm created for the holding pond.

parking lot had been converted into the holding pond. The north side of the pond is about eight feet above ground level and the south side is about ten feet above ground level since the parking lot slopes toward the river." He continues, noting the presence of abundant shell matrix and objects within the holding pond walls. Moreover, "the human remains were around the entire perimeter with a great concentration along the south (river) side. The southeast corner had the greatest number of human remains." The artifacts were in reverse stratigraphy, with Orange Plain and Incised sherds on the top, and St. Johns Plain and Check Stamped sherds at the bottom. He also notes preserved plant material co-occurred with Orange ceramics. The visit by McGee was followed up by a visit from Henry Baker for BAR, who concurred with McGee's findings.

Ms. Lou Groh was subsequently dispatched by BAR to monitor removal of the spoil from the holding pond. As part of the process she recorded the extent of disturbance on a hand drawn map (Figure 3-6a). She noted that the bottom of the holding area is hard and appears to be a matrix of shell and rock (possible concreted shell midden). Towards the river side the floor is soft and contains a shell layer. She inspected a cross-cut berm which was 3.2 m in height along the eastern side of the pond,



and described the stratigraphy, reconstructed in Figure 3-6b. At the base was a 50-cm thick layer of artifact-rich shell midden (containing one St. Johns Plain sherd, abundant *Viviparus* shell, and some human bone), that was laying atop the calcareous layer. She writes that “in this section of the site, the midden above the calcareous layer is entirely displaced.” It is unclear what she meant by displaced in this context, in particular whether the lower shell midden was intact. Above the shell midden layer, a 70-cm high layer of fill dirt was situated below the modern parking lot surface. Above this surface she noted shell midden that had been mined from the center of the parking lot.

Finally, in 2000, Lawrence Aten sent a letter to Jerry Milanich, of the Florida Museum of Natural History, regarding his childhood memories of the Thursby midden. He noted that the Thursby area had been leveled to construct houses, and that “the Thursby Mound was no longer visible but a sizable remnant of the midden existed in the area of the parking lot now used by the State Parks people as a landing for their ferry to Huntoon [sic].” He recalled digging in this area, and discovered fiber-tempered and St. Johns pottery. He notes excavating on the back side of the midden area (1/10<sup>th</sup> of a mile back) and locating *in situ* deposits including three burials.

In sum, the extant literature suggests that human remains are present across the parking lot area, from north to south. Intact deposits are expected outside of the center area mined for the holding pond. Finally, an intact profile of the site appears to consist of 70 cm of overburden laying above 50 cm of intact shell midden containing human remains.

## IMPLICATIONS

A review of the extant literature on previous excavations within the boundaries of Hontoon Island State Park indicates that there is significant likelihood of intact deposits within the APE. Although intact deposits are no doubt present across much of sites 8VO202 and 8VO2600, there are two particularly sensitive areas. The western end of site 8VO202 is known to contain human remains within intact archaeological deposits. These deposits are characterized by concreted shell midden, that may have been left behind by shell miners because it was too difficult to extract. By extension, it is unlikely that the current trail was excavated into this concreted shell, and that intact deposits are likely beneath the current ground surface. Elsewhere along the APE within site 8VO202 the potential for near surface intact deposits is unknown. Coring conducted in 2003 suggests that upwards of 50 cm of fill may be present across much of the improved park. The second area of concern is the western margin of the parking lot. Although heavily disturbed by bulldozers, the margins of the lot were apparently kept intact. Based on observations made at the time of the destruction, human remains, likely *in situ*, are present below 70 cm of parking lot fill. Outside the boundaries of these two sites the likelihood of encountering archaeological deposits is low to moderate. Areas with a higher probability of containing prehistoric deposits would be those situated along any low-lying wetlands, such as near the trail between the campgrounds and site 8VO202.



## CHAPTER 4 SURVEY METHODS AND RESULTS

This chapter summarizes the results of testing the approximately 1700-m-long APE corridor. We first review the survey methods employed, including testing strategies, recording procedures, and mapping protocols. We then provide detailed discussions of the subsurface reconnaissance results within the project area.

### METHODS

The proposed ground-disturbing activities have the potential to adversely affect intact archaeological deposits, but the depth of intact deposits across 8VO202 and 8VO2600 varies appreciably. Thus, the chief objective of the archaeological assessment within site boundaries was to document the depth of contact between modern, near-surface disturbances and intact archaeological deposits. Outside the boundary of 8VO202, the archaeological assessment involved Phase I reconnaissance to identify undocumented archaeological deposits.

Approximately one-third of the APE lies within the boundaries of sites 8VO202 and 8VO2600. As discussed in Chapter 3, expansive subsurface midden and basal components of ridges and sand mounds documented in the 19<sup>th</sup> century remain intact at both localities. Archaeological deposits are expected in all portions of the transect traversing 8VO202, but the depth of intact deposits below the present surface will vary from shallow to deep. For instance, the open, grassy area containing the pavilions and playground that was leveled and filled after mining likely contains no intact archaeological deposits in the upper 50 cm, whereas the area to the west of the visitor center has intact deposits at the surface. This latter area, particularly the region where the trail turns to the south, may have been avoided by the mining operation because it contains both concreted midden and human remains. Archaeological deposits are expected along the entire corridor within 8VO2600. Although significantly disturbed by bulldozing, it is possible that intact deposits are present below 70 cm of fill.

Because archaeological deposits are known to be present along the entire transect traversing 8VO202 and 8VO2600, the objective of archaeological assessment was not Phase I reconnaissance, but rather determination of depth of intact deposits. The usual 30-m interval of shovel tests for Phase I reconnaissance would be insufficient to provide an accurate account of depth below surface because subsurface disturbances vary across the site. Instead, we excavated STPs at 10-m intervals to achieve the level of resolution necessary to provide an accurate map of intact subsurface remains. This transect was denoted "Transect K," in keeping with the serial nomenclature developed during the 2003-2004 St. Johns Archaeological Field School. Shovel tests measuring 50-by-50 cm in plan provided sufficient exposure to detect facies between intact and disturbed deposits. Each STP was excavated to a depth of 1 m below surface when possible. In some cases, STPs could not be excavated to this depth due to the presence of concreted shell midden. When necessary, a 3-inch Dutch gouge auger was used to break through the concreted matrix to a maximum depth of 1 m. In other cases, buried utilities

prevented excavation altogether. Additionally, judgmental auger tests were sunk near STPs to clarify stratigraphic relationships.

Following subsurface investigations, a Nikon DTM-310 total station was used to map the location of all tests within the boundaries of 8VO202. Initially, the data points were referenced to the local floating grid established by the St. Johns Field School. These points were then georeferenced to real-world coordinates in UTM projection. Georeferencing was accomplished through a variety of means. The points were initially rotated and roughly positioned using GPS coordinates. Then, points were sited to features visible on a digital orthophoto with 6-inch pixel resolution. The high resolution of the imagery allowed acquired points to be georeferenced with a horizontal accuracy estimated to +/- 1-m error. Vertical estimates were acquired from the Volusia County digital terrain model (DTM). This DTM has a vertical accuracy of 0.3 foot RMSE, and is provided in absolute elevation above the North American Vertical Datum (NAVD) of 1988. These extrapolated values are used in the subsequent results section.

Our intent was to use this same subsurface testing and mapping strategy at site 8VO2600. However, we were forced to abandon this plan upon visiting the site. The APE corridor for the water main also contains buried cable and electric cables. A single auger test was placed adjacent to the APE. This auger yielded a human tooth, and at the request of BAR archaeologists no further testing was conducted within the boundaries of 8VO2600 (see below).

The majority of the APE lies outside of known site boundaries, and generally follows an existing trail leading to the campground and ranger residences. Archaeological materials are found occasionally along this entire stretch of road, but most, if not all, of these items, including shell, have been displaced from shell midden of 8VO202 as the roads were graded over the past few decades. Shovel testing along this portion of the transect entailed the recommended Phase I reconnaissance method of 30 x 30-cm STPs placed at 30-m intervals. The primary goal of this testing was to determine the presence/absence of archaeological deposits.

A representative profile of each shovel test was recorded for purposes of transect interpolations, and digital photographs were acquired for many positive shovel tests. All fill from STPs and auger tests was passed through ¼-inch hardware cloth and all recovered archaeological materials were bagged and labeled by STP number, and given a serial bag number. In the lab, artifacts were washed, sorted, and cataloged. All procedures conformed to Chapter 1A-46, Florida Administrative Code and the Cultural Resource Management Standards and Operation Manual (FDHR 2002).

#### 8VO202 – HONTOON ISLAND NORTH

Investigations of 8VO202 resulted in a total of 38 STPs and 3 judgmental auger tests (Figure 4-1). Testing was initiated at the southwestern terminus of the site, where non-shell midden deposits were identified below road fill. This midden was bounded to

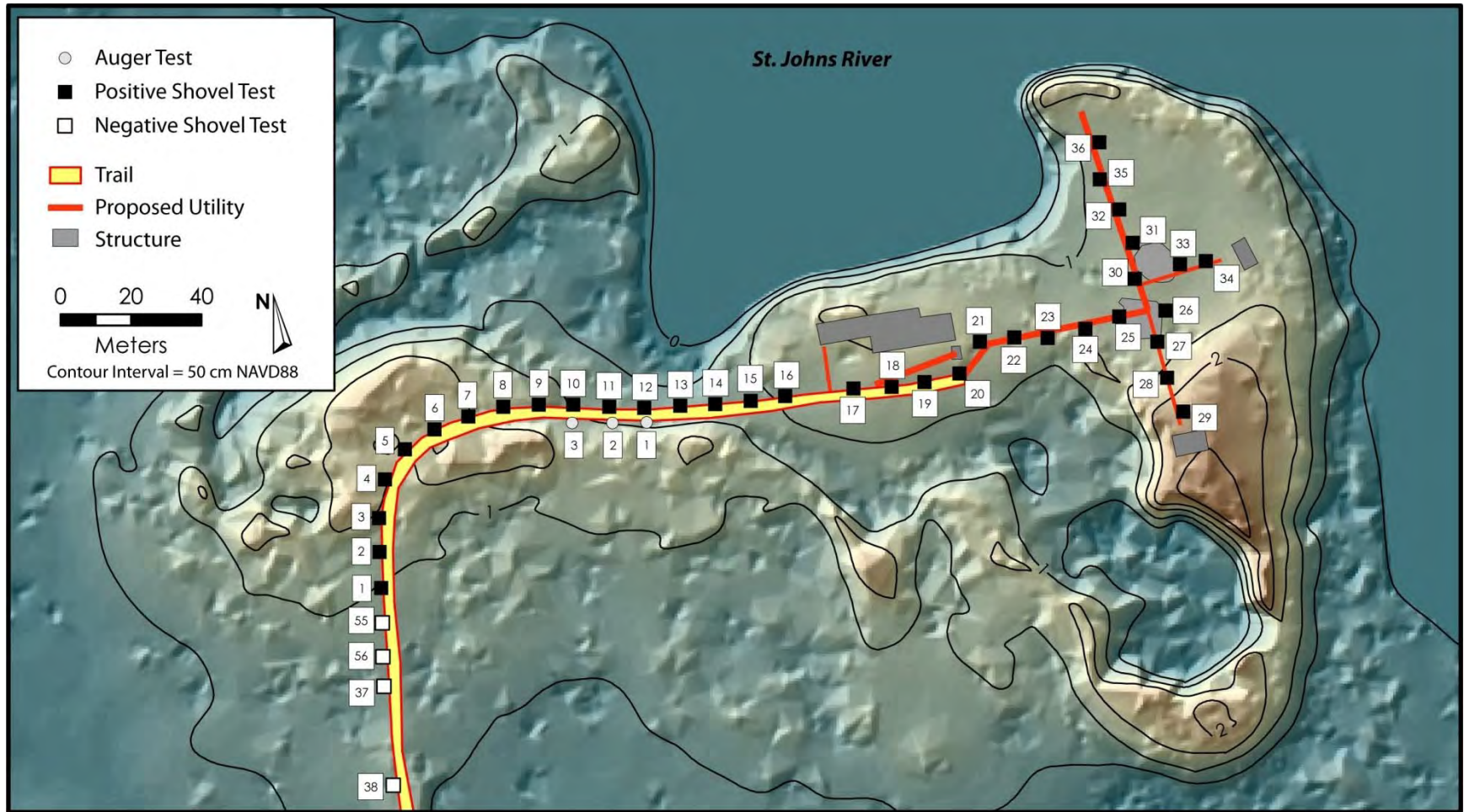

Figure 4-1. Location of shovel test pits and auger tests along the APE within the boundaries of the Hontoon Island North site, 8VO202.

the south by two negative STPs at 10-m intervals. Testing within 8VO202 continued to the north and east, where shell midden was found at varying depths. Within the trail segment of the APE, STPs were located immediately adjacent to, or partially within, the trail bed. Three auger tests were emplaced along the mined ridge escarpment on the south side of the trail as well. Outside of the trail segment to the east, STPs were placed roughly in-line with the sited utilities corridor. When trees, structures, or buried service water lines were present, the STP was offset by a meter or less from this projected corridor. In two cases, STPs could not be executed. Marked and buried telephone lines near the ranger station resulted in a 20-m interval between STP-16 and STP-17. In addition, we could not test the northernmost extension of the corridor at the directional drill location because of marked buried cables. In both cases, consistent stratigraphy between multiple STPs in the vicinity indicates that the avoided areas likely do not differ significantly with respect to the surrounding subsurface terrain. Finally, an auger was used in all STPs that intercepted concreted shell midden, as we could not penetrate the matrix with a shovel.

### *Subsurface Topography Overview*

Stratigraphy recorded during testing provides the starting point for identifying the depth of disturbances across the site. We first describe the macro-stratigraphy identified during testing. Spatial patterning in the depth and character of intact deposits will then be used to separate segments of the APE into zones for more detailed discussions.

In order to better visualize the results in regards to the proposed utility repairs, we have constructed subsurface profiles along north-south and east-west transects. These profiles that form two segments of Transect K within 8VO202 are presented in Figures 4-2 and 4-3. Figure 4-2 depicts a transect from STP-1 at the southwest trail edge of the site, to STP-34 adjacent to the pavilion on the eastern edge of the recreational area. This profile includes areas within both the trail and non-trail refurbishment segments of the APE. Figure 4-3 depicts a transect coursing from STP-36 near the directional drill location at the northern point of the recreational area, to the southern end of the APE adjacent to the bath house. Both figures include the absolute elevations of significant strata identified within STPs, including the surface and subsurface contact between near-surface disturbed strata and lower intact deposits. Where identified during testing, the basal sterile sand and the post-mining buried A-horizon are denoted. The minimum depths of planned disturbances for each STP are also provided. Basic data for these figures are provided in Table 4-1. Note that in many cases we did not encounter basal sterile deposits, due to the depth limitations of shovel testing and augering.

Seen in profile view, and as suggested by the literature review, the surface and subsurface topography varied greatly across the APE within 8VO202. Surface topography is characterized by a mildly undulating surface. The highest elevations are present at the southwest and southeast aspects of the APE. These areas correspond to two areas that were likely left behind by mining. In contrast, lower surface elevations and flat-lying terrain are found fronting the harbor and along the now-developed eastern

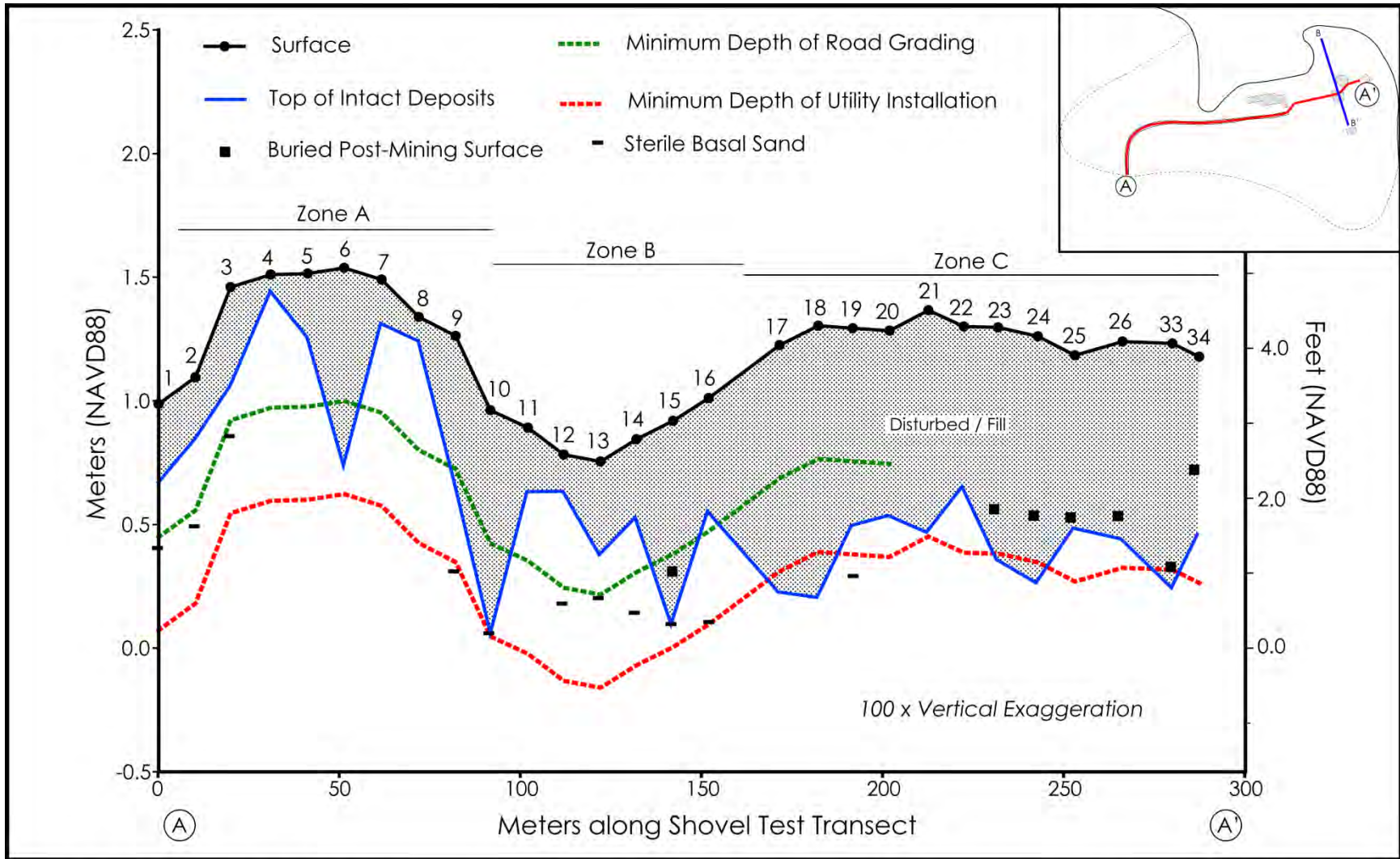

Figure 4-2. Subsurface profile along transect, showing depth of intact deposits below surface and minimum depths of proposed disturbances.

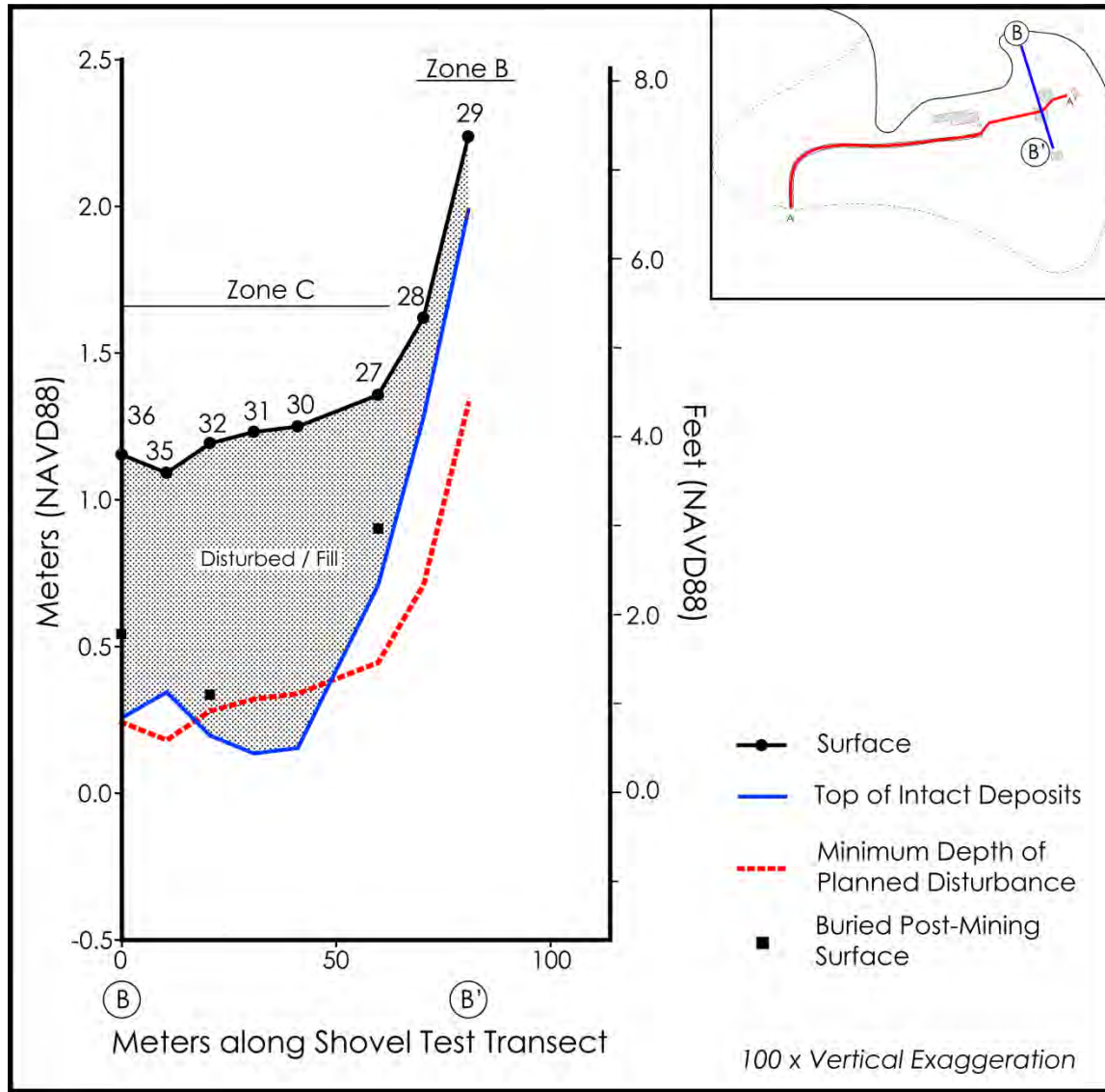

Figure 4-3. Subsurface profile along transect, showing depth of intact deposits below surface and minimum depths of proposed disturbances.

aspect of the site. Across the expanse of 8VO202, the depth of intact deposits ranged from a minimum of 7 cm below surface (hereafter BS) in STP-4 to a maximum of more than 100 cm BS in eight widely separated STPs. Basal sterile sand was encountered in only 11 STPs, which tended to be concentrated in the area closest to the lagoon, between STP-9 and STP-18. Concreted shell midden was encountered in seven STPs, all concentrated in the western APE segment. In all but one of these STPs the concreted shell was found near surface, between 7 cm and 26 cm BS. Also identified during testing was a buried A-horizon, which is concentrated in the open recreational area to the east. This organically enriched shell-bearing stratum routinely produced historic or modern artifacts. We do not consider it an intact pre-mining surface. Instead, it likely reflects the post-mining surface that was covered by fill before and while the island was converted to a State Park.



Table 4-1. Summary of STP and Auger Tests within the Boundaries of Site 8VO202.

Test Type	ID	Intact Depth Below Surface*		Basal Sand		Buried A-Horizon		Concreted Shell	Utility Depth		Zone
		cm	in	cm	in	cm	in		cm	in	
STP	1	32	13	58	23						A
STP	2	25	10	60	24						A
STP	3	40	16	60	24						A
STP	4	7	3					Y			A
STP	5	26	10					Y			A
STP	6	80	31								A
STP	7	18	7					Y			A
STP	8	10	4					Y			A
STP	9	60	24	95	37			Y	25	10	A
STP	10	(100)	(39)	90	35						B
STP	11	26	10					Y			B
STP	12	15	6	60	24			Y			B
STP	13	38	15	55	22				25	10	B
STP	14	32	13	70	28						B
STP	15	82	32	82	32	70	28				B
STP	16	46	18	90	35						B
STP	17	(100)	(39)						55	22	C
STP	18	(100)	(39)								C
STP	19	80	31	100	39						C
STP	20	75	30								C
STP	21	90	35								C
STP	22	65	26								C
STP	23	94	37			73	29				C
STP	24	(100)	(39)			72	28				C
STP	25	70	28			65	26				C
STP	26	80	31			70	28				C
STP	27	65	26			45	18				C
STP	28	34	13								D
STP	29	25	10								D
STP	30	(100)	(39)								C
STP	31	(100)	(39)								C
STP	32	(100)	(39)			85	33				C
STP	33	(100)	(39)			90	35				C
STP	34	72	28			45	18				C
STP	35	75	30								C
STP	36	90	35			60	24				C
DGA	1	70	28								B
DGA	2	26	10	66	26						B
DGA	3	17	7	68	27						B

\*Depths in parentheses denote the maximum depth of the test, and indicate that no intact deposits were identified during excavation.

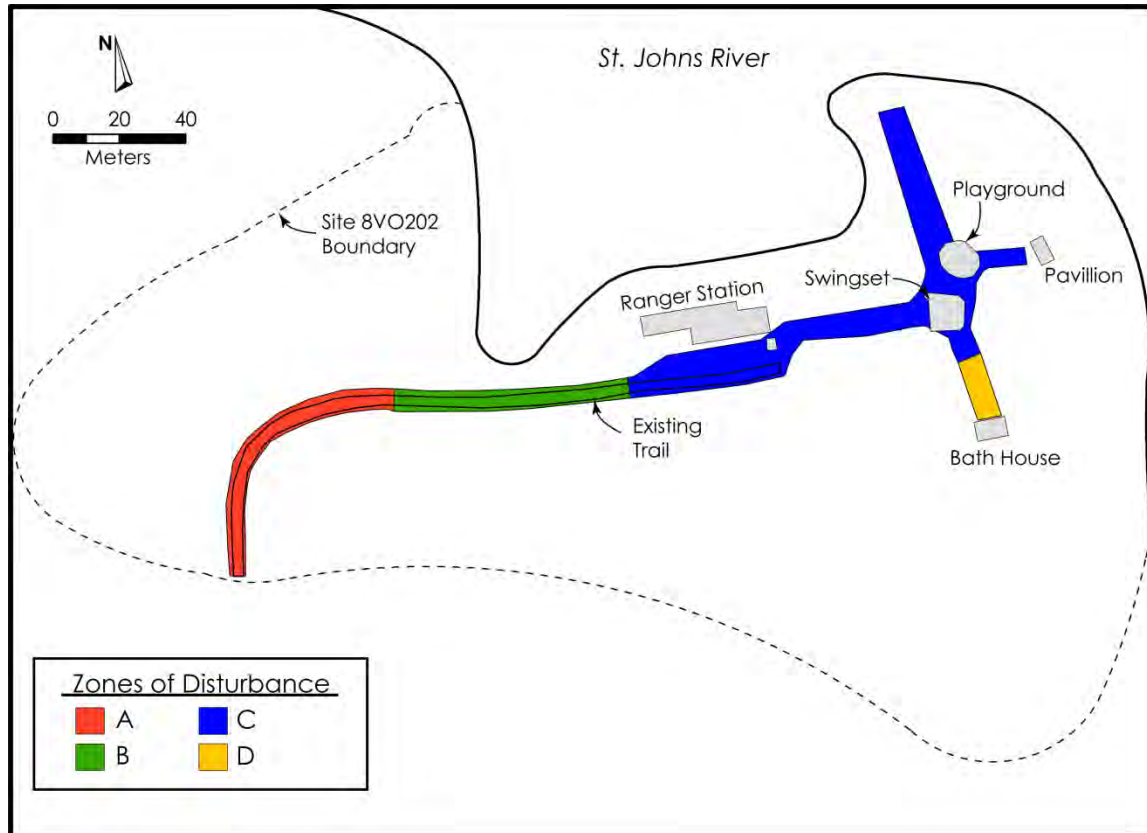

Figure 4-4. Zones of disturbance identified along the APE within the boundaries of the Hontoon Island North site, 8VO202.

We also encountered buried utilities in three tests, all higher than expected. In STP-9 and STP-15 we intercepted a PVC pipe and cast iron pipe, respectively. Both were 25 cm BS, but were expected to lie at least 76 cm BS (Randy Strange, personal communication). This shallower depth may be due in part to the frequent flooding and removal of fill along this portion of the road. Near the ranger station we also intercepted a rubber-coated cable of unknown function. The cable was located 55 cm BS, in a visible trench (see below). The implication of these findings is that the proposed project will have to excavate below the current depth of disturbance for the extant utility trenches.

Although varied, there are distinct “Zones of Disturbance” that we subdivided for ease of discussion and management purposes. The extent of these zones are presented in Figure 4-4. A number of characteristics were taken into account, including the depth of intact deposits, the matrices present, surface topography, and the nature of disturbance. These zones provide a framework for the following discussion of subsurface deposits across the APE. Individual management recommendations are provided for each zone as well.



Figure 4-5. View of trail segment at south end of the Hontoon Island North site, 8VO202, facing north. This area is encompassed by Zone A.

#### *Zone A*

Zone A is situated between STP-1 and STP-9. Topographically, this zone is characterized by a rise from the south to the east, and corresponds to the bend in the trail (Figure 4-5). Beginning at the southwest aspect of 8VO202, the trail rises roughly 50 cm from the surrounding wetlands in the vicinity of STP-1, and drops back down in elevation between STP-9 and STP-10. The area in between these STPs roughly corresponds with the Preceramic Archaic period dome of concreted shell midden identified during previous testing.

Several stratigraphic profiles were evident in this locality (Figure 4-6). Our initial tests, STP-1 and STP-2, were located on the southern, lower edge of 8VO202, near the hydric hammock. Although varying in the amount of shell midden present, these deposits appear to reflect the lateral extension of deposition at 8VO202. STP-1 was emplaced adjacent to the western edge of the trail, at the base of the shell deposit. The upper 32 cm were characterized by a mottled brown/black fine sand with occasional shell, road gravel, and large concreted clasts at the base (Figure 4-6a). These materials appear to represent disturbed fill, moved during the recurrent grading and resurfacing of the trail. Superficial cuts in the surface near the trail likely resulted from these trail



Figure 4-6. Photographs of shovel test pits excavated along Transect K within Zone A: (A) STP-1, (B) STP-5, (C) STP-6, (D) STP-9. Note, the photographs are not to scale and were acquired at an oblique angle.

regrading activities. From the base of this fill to 58 cm BS was an orange/brown shell-free midden with vertebrate faunal remains. This stratum is intact, and overlies a cemented white clayey sand which was impenetrable. STP-2 yielded a similar profile except the intact midden (below 25 cm BS) was characterized by moderate shell and vertebrate faunal bone. This was overlain by concreted white clayey sand.

Between STP-3 and STP-9, concreted shell midden was encountered at roughly the same depth throughout Zone A. In STP-3, intact shell midden was identified beneath 40 cm of light gray/brown sand with occasional shell and road gravel. The lower shell midden was dense, in a brown greasy sand, with low density vertebrate faunal bone. By 70 cm BS, this deposit was too concreted to excavate further. STP-4 was also emplaced on the western edge of the road, some 50 cm beyond the clear break between road and non-road terrain, and roughly 30 cm higher than the road bed itself. Below a shallow 7 cm thick light gray fine sand with some shell, we encountered an intact grayish brown ashy sand with high shell and bone density. By 57 cm BS this stratum became too concreted to excavate by shovel or auger.

STP-5 represented a shift in the composition of shell midden (Figure 4-6b). Below 26 cm of light gray sand with gravel that grades to brown/tan sand is a dense dark brown, greasy, semi-concreted shell midden. To a certain extent it is more compact than concreted, although it is nearly impenetrable. It is composed of some whole and crushed *Viviparus*, abundant ash, and some large mammal bone fragments. The observations in the field match those observed in a burial context some 10 to 20 m to the north of this area in TU2. An auger was used between 42 and 92 cm BS. At 92 cm BS, gray concreted and ashy sand with some crushed shell fragments was observed, as was trace bone fragments. Unlike the surrounding tests, STP-6 encountered what appears to be a highly disturbed mixture of banded light gray sand and low density shell midden with dark/brown sand matrix to a depth of 100 cm BS (Figure 4-6c). The intercalation of mottled sand and lenses of shell midden appear to represent either fill or regrading efforts. However, because no modern or historic materials were recovered from this stratum, it is also possible that the lenses actually represent mound fill, as seen at mortuary mounds elsewhere in the region. Regardless, an ashy gray sand with some shell was encountered at 100 cm BS in an auger test, suggesting that intact concreted shell is present at the base, and perhaps even higher.

Both STP-7 and STP-8 encountered a brown/gray intact ashy and greasy sand within which some whole and some crushed shell was present. In both cases, this midden was fully concreted below 18 cm BS. Auger tests from this depth to 80 cm BS encountered a similar midden, and were terminated because the base was entirely concreted. This same intact concreted midden was encountered at 49 cm BS in STP-9. The upper portion of the STP was disturbed, apparently during installation of a PVC force main, which we encountered at 25 cm BS (Figure 4-6d). At 80 cm there is a gray/brown shell midden which is semi-concreted, and contains abundant bivalve, and below that is gray sand at 95 cm BS that grades into a gray/white wet clay sand.

Table 4-2. Cultural Materials Recovered from Shovel Test Pits in Zone A, site 8VO202.

Provenience	<u>Lithic Flake</u>		<u>Marine Shell</u>				<u>Vertebrate Fauna</u>			
	ct	wt	<u>Modified</u>		<u>Unmodified</u>		<u>Modified</u>		<u>Unmodified</u>	
	ct	wt	ct	wt	ct	wt	ct	wt	ct	wt
STP-1	1	0.3			1	0.3	1	6.0	14	43.4
STP-2	1	0.3							47	40.0
STP-3									14	8.7
STP-4					1	10.3	2	43.9	38	54.7
STP-5									10	70.6
STP-7			1	14.2					12	23.7
STP-9					1	80.7			5	19.0
Total	2	0.6	1	14.2	3	91.3	3	49.9	140	260.1

All cultural materials recovered from Zone A are consistent with a Mount Taylor period assemblage. A summary of the artifacts recovered from this zone is provided in Table 4-2. Modified materials were limited to a marine shell tool fragment (Figure 4-7f), and a cut-and-snapped antler tine (Figure 4-7g). Otherwise, the artifact assemblage consisted of lithic waste flakes, unmodified marine shell fragments, and unmodified vertebrate faunal remains. It should be noted that the relative low-density of materials recovered is due more to our inability to fully excavate the midden matrix than to a lack of materials present.

Testing within Zone A determined that dense and concreted intact shell midden deposits are present with both the depths proposed for trail and utility trench excavation. Based on previous investigations and the material culture recovered in the current project, deposits in this area date to the Preceramic Archaic Mount Taylor period. While some deposits appear to represent lateral extensions of the midden (particularly at the south end of the site), those near the bend in the road may be associated with an Archaic mortuary. This inference is based on the presence of human remains near the trail, and the presence of both organic and concreted shell midden materials. No human remains were encountered during the present survey. From a management perspective, intact deposits within Zone A appear to be confined to a stratum of concreted shell midden that measures upwards of 80 cm thick. As shown by STP-6 and STP-9, localized disturbances are expected throughout the APE.

### *Zone B*

Zone B is represented by STP-10 through STP-16. This zone encompasses a relatively low-lying area that is bounded between a mining escarpment to the south, and the harbor to the north (Figure 4-8). In general, deposits in this area are characterized by a relatively thin intact and diffuse shell midden overlain by trail fill. A summary of cultural materials recovered from Zone B is provided in Table 4-3.

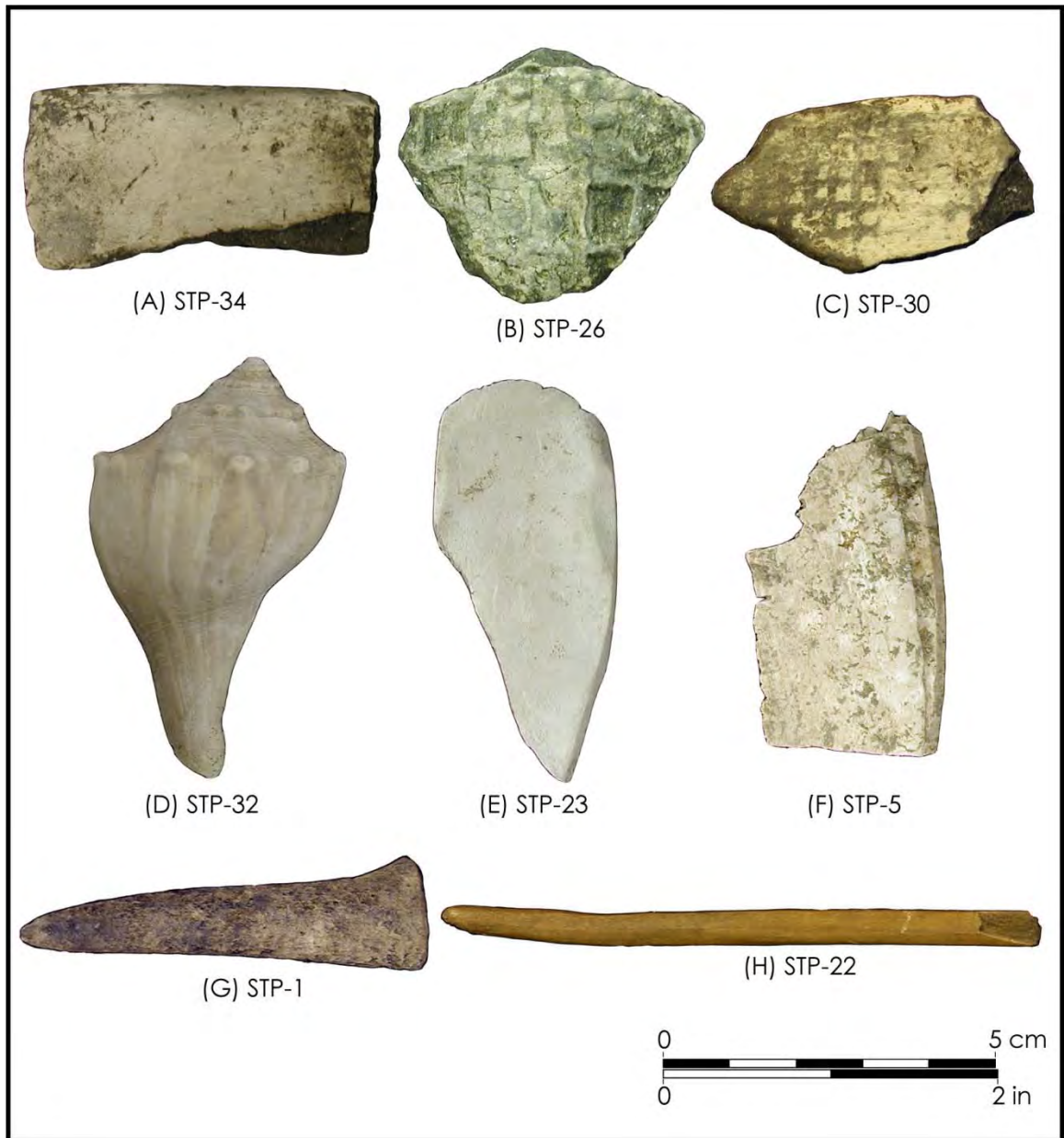

Figure 4-7. Select artifacts recovered during testing of site 8VO202: (A) St. Johns Plain sherd, (B-C) St. Johns Check Stamped sherds, (D-F) marine shell tools, (G-H) bone tools.



Figure 4-8. Photograph of Zone B, facing to the east. Pin flags denote the location of STPs tested along the northern margin of the APE corridor.

Table 4-3. Cultural Materials Recovered from Shovel Test Pits in Zone B, site 8VO202.

Provenience	St. Johns Plain		Unmodified Marine Shell		Vertebrate Fauna				Glass	
	ct	wt	ct	wt	Modified		Unmodified		ct	wt
STP-10			2	4.8			3	3.8		
STP-11							2	0.9		
STP-12	1	3.4					4	2.4		
STP-13					1	5.5	3	5.4		
STP-14	1	12.3								
STP-15			1	15.1			10	53.5	2	10.9
Auger-1							1	0.2	11	5.9
Auger-2					1	0.5	1	3.1		
Auger-3							3	1.1		
Total	2	15.7	3	19.9	2	6	27	70.4	13	16.8



Beginning with STP-10, we encountered a highly disturbed strata at the surface of the trail. This matrix was composed of discontinuous lenses of shell midden (both concreted and loose), in addition to gray sand, and clasts of black/brown spodic sand. In some cases, this spodic sand contained rootlets and other vegetation fragments. It is likely that these clasts are ultimately derived from a wetland or other saturated organic sediment source that was mined, possibly in part as fill. In STP-10 this matrix continued from the surface to 90 cm BS. It was first seen in the test pit, and then in the auger test used after the matrix became too difficult to excavate via shovel. Below 90 cm we identified a wet gray/grown sand that was culturally sterile.

Aside from STP-10, most STPs within Zone B encountered some intact shell midden. In STP-11 the disturbed matrix was identified to 30 cm BS (Figure 4-9a). Below the fill was a dark gray, ashy, and almost wholly concreted shell midden that appears intact. The test pit excavation was stopped at 40 cm BS and continued with an auger, but we could not excavate to the bottom due to concretion. STP-12 had a disturbed horizon to 15 cm, underlain by a dense and concreted shell midden to a maximum depth of 60 cm BS as determined by augering through the concreted midden. While this midden appeared intact, a St. Johns Plain sherd was recovered from within it. It is possible it is somewhat disturbed. However, given that we do not know the exact configuration of the overlying ridges, it is possible that this area of the site was deposited during the St. Johns era. Below 60 cm BS there is a dark brown shell-free sand that appears to be culturally sterile.

In STP-13 we identified a disturbed and variegated loose *Viviparus* midden with occasional spodic clasts to 55 cm BS. Within this matrix was a cast iron pipe at 25 cm BS (Figure 4-9b). Continued augering below the base of the cast iron pipe identified an ashy gray shell midden to a depth of 55 cm BS. Given the small diameter of the auger it was impossible to discern whether this midden was intact. This shell midden was underlain by an intact gray shell-free sand that was apparently culturally sterile. Because of difficulties in determining if the lower gray shell midden was indeed intact, we augered on the south side of the road, across from STPs-10, -11, and -12. The augers were situated at the base of the mined-shell escarpment. Auger tests 2 and 3 yielded a gray, ashy shell midden between 40 and 70 cm BS at a minimum, underlain by wet culturally sterile sand. The presence of these strata adjacent to the intact mining escarpment suggests that the midden is present across much of Zone B, albeit impacted in portions by extant utilities and trail regrading. Auger test 1 was less conclusive, as glass fragments were recovered down to a depth of 70 cm within shell midden. Whether these fragments were derived from a near-surface deposit could not be discerned in the field.

The eastern segment of Zone B is more deeply disturbed than the western portion. In STP-14 mottled soil was encountered to 50 cm BS, and then a brown sand with abundant shell was encountered in the auger test to a depth of 70 cm BS. Below 70 cm that was a shell-free wet brown sand. STP-15 encountered disturbed fill to a depth of 38 cm BS (Figure 4-9c). Below the fill was a moderately loose gray/brown sand with abundant *Viviparus* shell, in addition to notable whole apple and bivalve. The presence of roots throughout this zone, and the generally homogeneous appearance, indicates that



Figure 4-9. Photographs of shovel test pits (STP) excavated along Transect K within Zone B: (A) STP-11, (B) STP-13, (C) STP-15, (D) STP-16. Note, the photographs are not to scale and were acquired at an oblique angle.

this midden matrix represents the top of a surface. Although no modern or historic artifacts were recovered, we believe this represents a surface left after shell mining, and is thus not intact. Wet sand was encountered at 82 cm BS. Finally, in STP-16 we encountered banded disturbed soil to 46 cm BS, below which was an intact, semi-concreted shell midden in grayish brown ashy soil (Figure 4-9d). Dark brown sand was noted at 90 cm BS.

The presence of intact and disturbed strata throughout Zone B is mirrored in the recovered artifact assemblages. Glass fragments were identified in one STP and an auger test. In addition, two St. Johns Plain sherds were encountered in two STPs. Otherwise, much of the intact midden in this zone appears to date to the Preceramic Archaic Mount Taylor period. Intact deposits are confined to a roughly 20-40 cm thick stratum overlain by fill. This fill was not seen in any tests within Zone A, but continues into Zone C (see below). The intact midden in this portion of the APE is underlain by a culturally sterile semi-saturated wet sand. The proposed project will remove almost all intact deposits in this zone. Based on testing elsewhere at 8VO202, the contact between basal shell midden and underlying sand has produced intact Preceramic-era pits and other features. We would note that these may be present in the APE as well, although none were identified during testing.

### *Zone C*

Zone C was isolated within 17 STPs across a wide expanse of the improved recreational area. Surface topography in this zone is flat, and slightly elevated above Zone B. In most areas the zone is characterized by mowed lawn or oak trees (Figure 4-10). In addition to the ranger station in front of the lagoon, other surface improvements include playgrounds, a pavilion, and a bathhouse. Subsurface utilities are evidenced by buried cable markers near the ranger station and at the northern point. With a few exceptions, STPs within Zone C yielded highly comparable results (Figure 4-11). These profiles reflect a subsurface disturbance regime resulting from nearly a century of mining and construction. In several cases STPs were avoided due to the presence of marked utilities. This was the case for the area immediately behind the ranger station, and at the northernmost point of the park. A summary of the artifacts recovered from this zone is provided in Table 4-4.

The area around the ranger station has clearly been built up with fill, and modified during the construction of the building. Just south of the station, and still within the trail bed, we excavated STP-17. This STP bisected a ditch containing a rubber-coated cable to the north side, and disturbed spoil to the south half of the STP. The cable was buried 55 cm below surface, and the pit was filled with dark gray homogenous shell midden. The south side was characterized by spoil/fill material composed of concreted shell midden, white/gray sand, and clasts of spodic soil. An auger was used below 55 cm BS, and encountered a mottled gray/clayey low density shell midden, and which was likely intact at 100 cm BS. In both STP-18 and STP-19 disturbed fill was found throughout the test, to a minimum depth of 100 cm BS.



Figure 4-10. Photograph of the northern point of site 8VO202 within the recreational area, facing north. Pin flags denote the location of the APE corridor. The St. Johns River and Hontoon Island State Park parking lot/landing can be seen in the distance.

Beginning with STP-20 we encountered what appears to be traces of a well-defined shell midden surface, typically between 65 and 75 cm BS. In STP-20, 75 cm of gray mining spoil with modern and historic artifacts overlay a clayey brown *Viviparus* midden with St. Johns sherds. A similar profile was revealed in STP-21, where disturbed fill 90 cm thick overlay what may be an intact shell midden in gray sand at the base. Finally, STP-22 intercepted a marbled gritty sand with spodic soil clasts, white sand lenses, and midden clasts to 65 cm BS. Below that was a gray/brown intact sand with abundant *Viviparus*, some bivalve and large charcoal clasts, that contained bone and St. Johns pottery.

The presence of a well-defined subsurface contact was first identified in STP-23, and it persisted across the recreational area. Although superficially appearing like an intact prehistoric surface, the data available suggest that it is a post-mining surface that was filled over. In some cases this surface is characterized by a gray, ashy midden. For example, in STP-24, the upper 73 cm consisted of the usual fill, including shell midden clasts, spodic soil, and sand. Beneath the fill to 100 cm BS was a dark gray ashy shell midden with abundant St. Johns pottery and vertebrate fauna. This stratum also contained abundant relict roots, and had the appearance of a buried A-horizon. This basal shell strata was encountered at similar depths in STP-26, -27, -31, -32, -34, and -36. A representative photograph is provided in Figure 4-11b. A related stratum was



Figure 4-11. Photographs of shovel test pits (STP) excavated along Transect K within Zone C: (A) STP-25, (B) STP-32. Note, the photographs are not to scale and were acquired at an oblique angle.

encountered in STP-24, -25, -30, -33, and -35. As seen in Figure 4-11a, this matrix is characterized by a very dark gray/black organic shell midden with abundant rootlets running throughout. In some cases, such as STP-30, well preserved pine needles were also present. That these surfaces date to the post-mining era is evidence by nails, metal fragments, and glass that were recovered from these matrices in STP-27, -30, -31, -32, -33, -34, and -35. The disturbed mining surface varies in thickness across the recreational area, but is typically 10 to 20 cm thick. In some cases, it was found to overlay a more intact-looking *Viviparus* shell midden with abundant St. Johns sherds, vertebrate faunal bone, and other objects.

Finally, isolated human cranial elements were recovered in STP-34, and consist of five fragments of temporal bone. The stratigraphy of the STP is characterized by the following: 0-20 cm BS light gray sand; 20-45 cm BS mottled white/brown sand, peat clasts, and trace amounts of shell (fill); 45-72 cm BS compact organic shell midden with nails and plaster fragments (buried A-horizon); 72-100 cm BS ashy sand with dense shell (likely intact). These fragments were positively identified only after they had been

Table 4-4. Cultural Materials Recovered from Shovel Test Pits in Zone C and Zone D, site 8VO202.

Provenience	Pottery								Lithic				Marine Shell			
	St. Johns Plain		St. Johns Check Stamped		Other		Crumb Sherd		Flake		Ground Stone		Modified		Unmodified	
	ct	wt	ct	wt	ct	wt	ct	wt	ct	wt	ct	wt	ct	wt	ct	wt
<i>Zone C</i>																
STP-17	1	3.4							1	1.0						
STP-20	1	10.9														
STP-21	1	3.1														
STP-22	2	11.4			2 <sup>a</sup>	6.0	5	4.3								
STP-23	4	13.0					6	5.0				1	10.0	1	3.1	
STP-24	12	35.2	2	6.9			12	11.9				1	6.6	1	1.7	
STP-25	9	42.8	1	1.4			6	3.9						3	12.1	
STP-26	14	52.1	4	22.1			6	5.3						1	4.1	
STP-27	37	149.8	12	43.4			20	20.7								
STP-30	4	50.7	2	7.8			1	0.7	2	11.2						
STP-31	11	68.4	1	4.0			6	4.7	1	2.5					1	1.8
STP-32	7	34.2	1	4.1			1	0.7				2	23.5			
STP-33																
STP-34	22	151.2	3	9.2			17	17.9								
STP-35	2	2.4														
STP-36	1	1.9														
Total - Zone C	128	630.5	26	98.9	2	6.0	80	75.1	4	14.7			4	40.1	7	22.8
<i>Zone D</i>																
STP-28	35	134.9	5	8.7			42	24.3								
STP-29	81	313.1	33	115.8	1 <sup>b</sup>	1.1	120	70.5			1	5.9			3	12.7
Total - Zone D	116	448.0	38	125.0	1	1.1	162	94.8			1	5.9			3	12.7

<sup>a</sup> Sand Tempered Plain<sup>b</sup> Orange Fiber-tempered Incised

Table 4-4 (continued).

Provenience	Vertebrate Fauna				Historic/Modern									
	Modified		Unmodified		Paleofeces		Construction		Glass		Metal		Plastic	
	ct	wt	ct	wt	ct	wt	ct	wt	ct	wt	ct	wt	ct	wt
<i>Zone C</i>														
STP-17	1	1.6	4	2.4										
STP-20			1	1.2							1	4.7		
STP-21														
STP-22	1	2.4	10	19.7										
STP-23			7	10.7					4	4.0	1	9.0	1	0.2
STP-24	1	2.1	24	25.1	1	8.2								
STP-25			14	13.4										
STP-26			5	3.7										
STP-27			19	32.5					3	9.7	1	1.3		
STP-30	1	3.2	17	29.3			4	3.4	1	17.6	5	21.4		
STP-31	2	2.2	57	71.5					2	10.7			1	0.4
STP-32			25	45.2			4	0.8			1	1.8		
STP-33			4	5.0							4	8.8		
STP-34			10	9.5			1	6.7			2	7.5		
STP-35														
STP-36			5	2.6							1	1.1		
Total - Zone C	6	11.5	207	290.2	1	8.2	9	10.9	10	42.0	17	55.7	2	0.6
<i>Zone D</i>														
STP-28	1	2.6	27	25.3					4	13.4				
STP-29	1	3.6	211	124.5	1	0.3					3	3.3		
Total - Zone D	2	6.2	238	149.8	1	0.3			4	13.4	3	3.3		

cleaned and processed during laboratory analysis. Although not recognized as human during excavation, they were bagged separately. As a result, we know they were recovered between 55 and 65 cm BS. At this depth, the bones were associated with the post-mining buried A-horizon, and not the basal intact shell deposits. The adhering matrix is also consistent with the disturbed strata. This STP was offset approximately 1 m to the north of a current water-line, and demolition of that utility will not likely impact intact deposits in this locality.

Cultural materials recovered from Zone C indicate that the majority of the intact and mined materials date to the St. Johns period. Most diagnostic were the abundant St. Johns Plain (Figure 4-7a) and St. Johns Check Stamped sherds (Figure 4-7b,c). Also included in this inventory were a miniature modified whelk shell (Figure 4-7d), and a small shell celt fragment (4-7e). In addition to a few worked bone fragments, we also recovered a burnished bone fragment (Figure 4-7h). More recent materials included metal fragments, machine cut nails, small glass sherds, and construction materials such as plaster and asphalt shingle fragments.

#### *Zone D*

Zone D was delimited by STP-28 and STP-29, just to the south of the bath house. This zone is characterized by a relatively dramatic increase in surface elevation, from north to south. Based on previous excavations, it is thought that this elevation change reflects the residual apex of Hontoon Island North. The cultural materials recovered from this zone are all consistent with a St. Johns I or II cultural ascription (Table 4-4).

Both STPs encountered intact shell midden below a 15 to 20 cm thick root mat that contained some shell (Figure 4-12). This disturbed strata contained recent debris, including glass and metal fragments. In STP-28, a stratum characterized by semi-concreted *Viviparus* midden with abundant ash, some bivalve, and large charcoal clasts was below the surface matrix. This was underlain by a stratum consisting primarily of loose whole *Viviparus*, apple snail, and bivalve shell with very little non-shell matrix. Excavation of the STP was terminated at 75 cm BS because the profiles continually collapsed and filled the hole back in. Numerous St. Johns sherds, vertebrate faunal bone, and even marine shell were recovered. A similar intact deposit was encountered in STP-29. In this case, however, we also encountered an existing trench, likely excavated for the water service line to the bath house (Figure 4-12b). This trench is filled with dark gray sand and some shell, and has a maximum depth of 55 cm BS. The trench is roughly in line with the survey location of the water service pipe. As in STP-28, the midden was characterized by mostly whole shell with abundant St. Johns sherds, vertebrate faunal remains, and other objects.

Archaeological deposits are present near the surface within Zone D. However, if the proposed project limits impact to the existing water lines, disturbance here should be minimal. Based on the intercepted utility trench, it would appear that 40 cm of intact deposits remain below will be affected.





Figure 4-12. Photographs of shovel test pits (STP) excavated along Transect K within Zone D: (A) STP-28, (B) STP-29. Note, the photographs are not to scale and were acquired at an oblique angle.

#### 8VO2600 – THURSBY MIDDEN/HONTOON ISLAND PARKING LOT

Investigation of site 8VO2600 was restricted to a single auger test due to the discovery of a human tooth. The project specifications for site 8VO2600 call for installation of a water main line in the location of an existing utility corridor. This corridor travels down the western border of the parking lot, a distance of approximately 70 m from the main tie-in near Ridge River Road to the shore line of the St. Johns (Figure 4-13). Because of the high probability of intercepting buried utilities, we started reconnaissance 4.5 m to the east of the fence line (Figure 4-14).

As an initial test of the stratigraphy, we used a 3-inch Dutch gouge auger. We screened the extracted material and noted any soil color changes with depth. The upper 60 cm consisted of a gray/brown mottled sand with trace amounts of crushed shell fragments, and a few small bone fragments. This soil profile was consistent with the fill identified at 8VO202. Beginning at 60 cm BS we noted a darkening of the soil, to a brown fine sandy midden with a moderate density of shell, and abundant mammal and fish bone fragments. At around 70-80 cm BS we extracted a human tooth, which appears



Figure 4-13. Photograph of the APE corridor within site 8VO2600, showing marked utilities, facing north. The pin flag in front of the shaker screen marks the location of the auger test that yielded human remains.

to be a premolar that was heavily worn down and still attached to the root. We immediately checked through the other mammal bone fragments, but they were too fragmentary to discern if they were human. There are some long bone fragments in the assemblage that may be human. Given the small diameter of the hole, and the method of extraction, it was not possible to tell whether these were in primary context.

After discovery, we immediately contacted BAR archaeologist Louis Tesar, who advised that we photograph the tooth and return it to the excavation unit. Also at his advice we recorded the location of the tooth via GPS. In UTM coordinates (NAD83), Auger-1 is located at N3205433/E465203. Finally, in our phone conversations and via email, Louis Tesar suggested that “digging in the immediate area to determine if more remains are present is not recommended at this time.” We abided by this request and did not continue testing within the boundaries of 8VO2600.

Based on our own very limited investigations, it is unknown whether there are intact burials associated with the corridor, or whether the current utilities work has already disturbed below the stratum we encountered. The pipe is to be installed to a minimum depth of 36 in (91 cm) BS. This same corridor appears to also contain buried telephone power cables of unknown depth. It is possible that all of the utilities within the corridor have already disturbed deposits below this minimum depth, but we do not know.

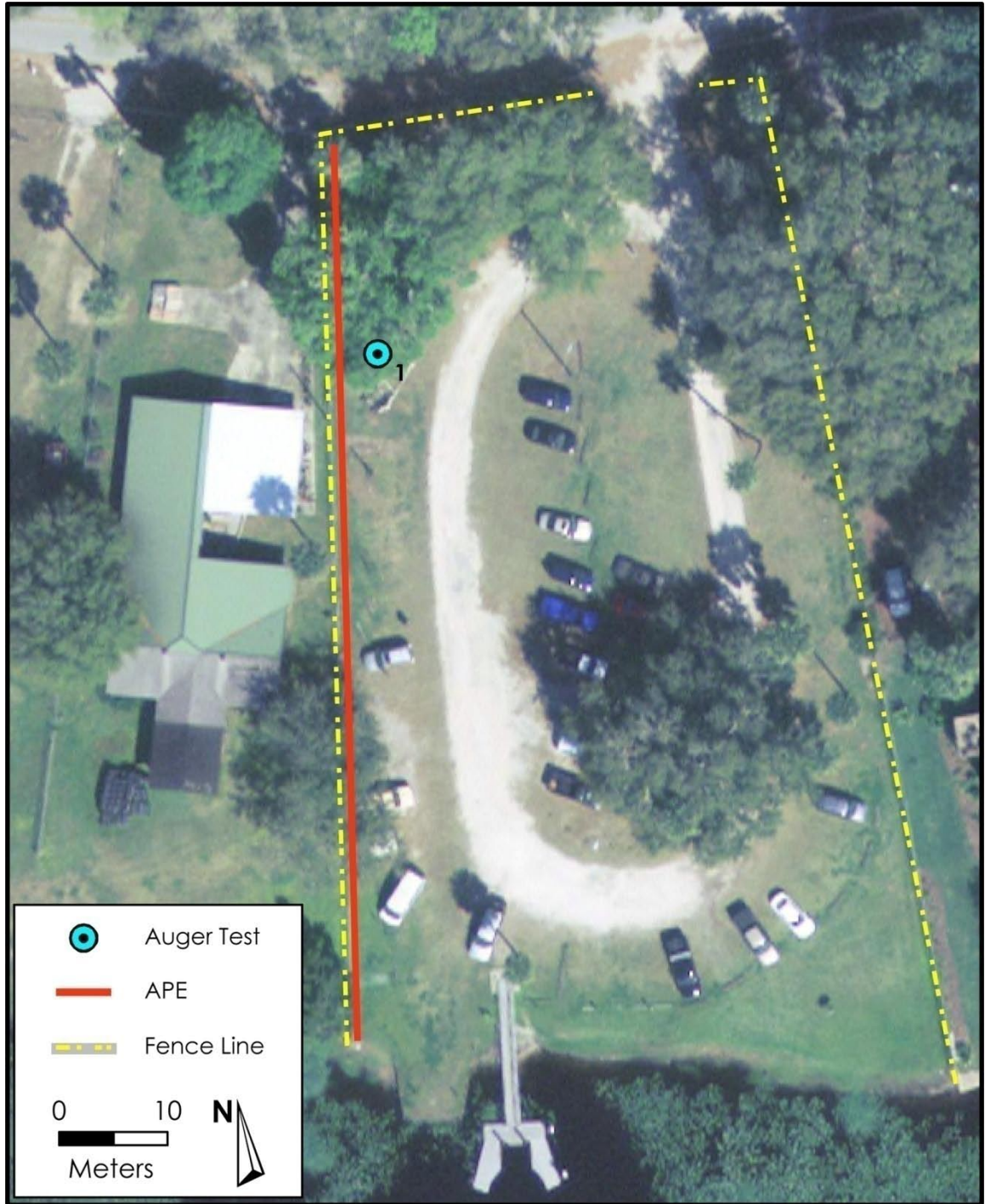

Figure 4-14. Location of auger test in the Thursby Midden/Hontoon Island Parking Lot site, 8VO2600.

The extant literature suggests that human remains are present across the parking lot area, from north to south. Intact deposits are expected outside of the center area mined for the holding pond. An intact profile of the site recorded by Groh consisted of 70 cm of overburden laying above 50 cm of intact shell midden containing human remains. These depth measurements are consistent with what we encountered in our auger test. On this basis, it would appear that (1) the depth of the tooth is consistent with a site-wide pattern, (2) there is a very high probability that human remains are present along the entire perimeter of the parking lot, and (3) significant disturbance is likely within the APE due to extant utility installation.

#### OFF-SITE RECONNAISSANCE

Shovel test reconnaissance outside of the boundaries of known archaeological sites resulted in a total of 29 STPs (Figure 4-15). Between the southern edge of 8VO202 and the camp sites, STPs were placed on the margin of the built-up trail bed on side. Within the campsite, ranger residences, and workshop area STPs were placed on either side of the trail in areas distant from trees. We avoided testing three STPs due to marked utilities. This included the front yards of the ranger station and the water treatment plant. However, stratigraphy in this area was consistent. Across the reconnaissance area no STP encountered cultural materials in an undisturbed context, although a few fragments of marine shell, vertebrate faunal bone, and one lithic flake were recovered in near-surface, highly disturbed fill contexts (Table 4-7).

Reconnaissance proceeded south from STP-1, along the elevated trail section (Figure 4-16). Between the southern border of 8VO202 and the campsites the road has been built up within a low-lying hydric hammock that lies between 0.5 and 1.0 m above NAVD88. A typical STP profile consisted of fill from 0 to 50 cm BS, black organic sand with abundant roots from 50 to 85 cm BS, and wet gray clay from 85 to 100 cm BS. The fill is characterized by banded lenses of gray, brown, or white sand with freshwater and marine shellfish fragments, gravel, and miscellaneous glass, metal, and plastic fragments. It is quite evident that shell midden from 8VO202 was dragged over much of the trail during regrading efforts in the past.

Table 4-5. Cultural Materials Recovered from Disturbed Contexts Outside of Known Site Boundaries.

Provenience	<u>Lithic Flake</u>		<u>Unmodified Marine Shell</u>		<u>Unmodified Vertebrate Fauna</u>	
	ct	wt	ct	wt	ct	wt
STP-37			1	2.2		
STP-54	1	1.2				
STP-55					1	4.7
STP-57			2	13.1		
Total	1	1.2	3	15.3	1	4.7

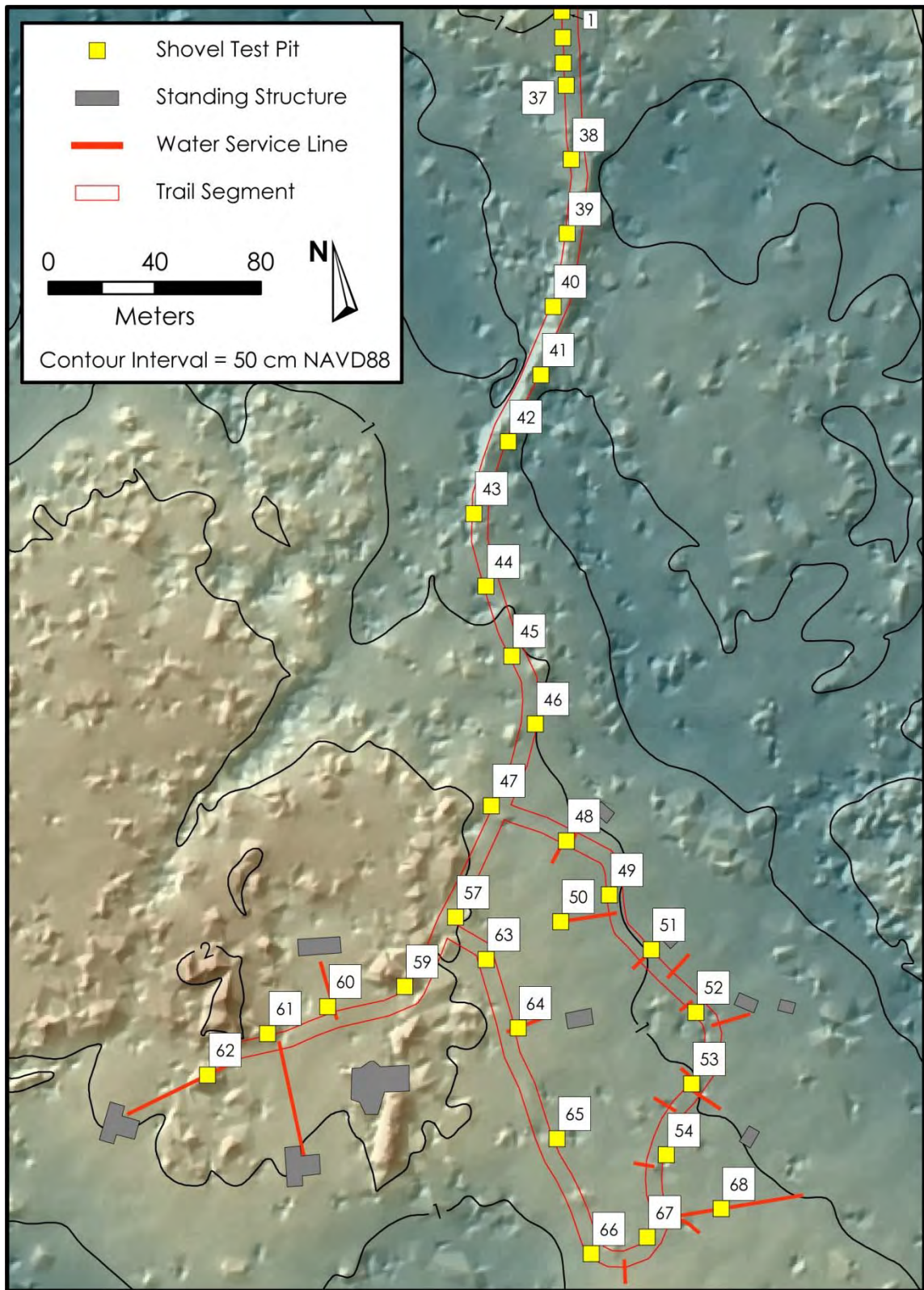

Figure 4-15. Location of shovel test pits (STPs) outside of known site boundaries.



Figure 4-16. Section of the elevated trail to the south of 8VO202, facing towards the north.

Near the southern border of the camp site area, the surface topography rises above 1.0 m NAVD88. Vegetation here is dominated by palmetto and slash pine, with occasional oaks throughout. A typical STP profile in the campsite and ranger residence area consists of mottled and disturbed trail fill from 0-30 cm BS, 30-60 cm BS light gray sand with occasional gleying, 70 cm BS brown sand, and 75+ cm BS gray/brown wet clay.

## CHAPTER 5 CONCLUSIONS AND RECOMMENDATIONS

The CRAS performed by the LSA in advanced of planned improvements to Hontoon Island State Park consisted of archival research and subsurface testing of the proposed APE. Archival research indicated that the APE will intersect two significant cultural resources, the Hontoon Island North site (8VO202) and the Thursby Midden/Hontoon Island Parking Lot site (8VO2600). Although extensively impacted by 20<sup>th</sup> century land use, both sites contain extensive intact subsurface deposits. Outside of the known site boundaries, the probability of encountering *in situ* archaeological deposits was considered unlikely. This chapter summarizes the results of testing within the APE, and provides recommendations for the proposed utility and trail repair project.

### SUMMARY OF RESULTS

Because both sites 8VO202 and 8VO2600 are known to contain intact archaeological deposits, the goal of the CRAS within these localities was to determine the depth below surface of intact strata. Methods were used to detail the subsurface contact between overlying fill and archaeological deposits. This strategy consisted of excavating shovel test pits (STPs) at 10-m intervals in addition to judgmental auger tests. Outside of known site boundaries, STPs were excavated at 30-m intervals to identify the presence or absence of intact archaeological deposits.

#### *8VO202-Hontoon Island North*

As expected, testing across site 8VO202 revealed the presence of intact archaeological deposits at variable depths within the APE. In general, most STPs identified a highly disturbed fill resting above unaffected strata. In some cases, archaeological remains were situated only a few centimeters below the surface, while in others intact strata were identified near the bottom of 1 m deep STPs. Otherwise, only a few STPs failed to identify undisturbed strata altogether. Although variable, the results of testing demonstrated that there are four spatially discrete zones with consistent matrix composition, culture-historical affiliations, and intact subsurface profiles. Each of these zones will be impacted differently by the proposed repair project (Table 5-1).

Zone A is situated at the southwestern edge of 8VO202, in an elevated bend in the trail. Previous investigations demonstrated that this area likely dates to the Preceramic Archaic Mount Taylor period, and is characterized by intact concreted shell midden that appears to have been avoided by shell mining during the 1930s. The current project adds further credence to that inference. In addition, Zone A may have been the locus of a Mount Taylor mortuary, based on the discovery of *in situ* skeletal elements by the St. Johns Archaeological Field School. No human remains were encountered in this zone during the present survey, but the presence of concreted shell midden was well documented. Based on testing, Zone A contains a minimum of 60 cm of intact shell midden, and likely more based on previous investigations. All cultural materials were

Table 5-1. Potential Impact to Zones within APE at site 8VO202.

Zone	Maximum Utility Depth		Minimum Intact Deposit Depth		Maximum Deposit Thickness*	
	cm	in	cm	in	cm	in
A	114	45	7	3	60	24
B	114	45	15	6	45	18
C	91	36	65	26	45	18
D	91	36	25	10	75	30

\*Maximum thickness of deposits based on observed stratigraphy. Deposits may in fact be thicker in areas where we could not excavate due to concreted deposits.

consistent with a Mount Taylor affiliation. In most cases, intact midden was encountered within 20 cm of the surface. In a few cases, however, STPs revealed disturbed strata to 100 cm below the current trail surface. It is likely that both intact and disturbed contexts are present throughout the zone. The proposed project will likely remove or compromise any intact deposits within the APE. After the upper 53 cm are completely removed, two trenches 61-cm deep will be excavated within the extant bed.

Zone B is bounded by a relict mining escarpment to the south and the Hontoon Island harbor to the north. This zone is also at slightly lower elevations than the rest of the APE within 8VO202. Intact deposits within Zone B are considerably thinner than other zones. Typically STPs encountered a highly intercalated fill with intact deposits occurring no more than 15 cm below the surface. Based on testing, intact midden is likely less than 45 cm in maximum thickness, and is situated on top of culturally-sterile basal sands. In some cases this midden was concreted, but others it was diffuse and unconsolidated. Excluding isolated St. Johns pottery, all materials are consistent with a Mount Taylor culture-historical affiliation. Like Zone A, this segment of the APE involves both trail excavation and utility installation. The total volume of midden to be displaced within Zone B will be lower than Zone A. However, most intact deposits will likely be removed within the APE given their relative proximity to the current trail surface. Although testing during the current project was limited, pits and other features have been identified in basal strata elsewhere within 8VO202, and if present these will be destroyed by the proposed improvements.

Zone C is an expansive area that encompasses the most improved areas of the park, including the ranger station and recreational areas to the east. This zone is also slightly higher in initial surface elevation than the adjacent Zone B. A consistent pattern was recognized across much of this landform that demonstrates a high level of disturbance due to shell mining and park development. Intact archaeological deposits were never located closer than 65 cm below the surface, and often at even greater depths. The overlying fill generally consisted of gray, brown, or white sand with lenses of either shell midden or spodic organic sediment. This fill appears to include materials both brought into the site as well as autochthonous shell midden. Moreover, we also isolated a buried A-horizon in many STPs. This surface was first encountered in cores by the St. Johns Archaeological Field School. At the time it was unknown if this surface was prehistoric in origin or if it registered a post-mining surface. During the current testing project we routinely recovered glass, metal fragments, and machine-cut nails. These



finds indicate that this surface represents a post-mining surface that was buried prior to or during Hontoon Island's conversion to a State Park. Below this stratum we encountered intact St. Johns-era archaeological deposits. Finally, we encountered isolated human cranial fragments in one STP. These remains appear to have come from the overburden and not intact strata. The proposed project within Zone C calls for the excavation and replacement of extant utilities. Based on the current data, this process should minimally impact extant intact deposits as long as contractors stay within the current utility trench boundaries.

Zone D is restricted to a marked rise in the surface topography, in front of the park's bath house. This area likely corresponds to the relict apex of site 8VO202 that was removed during shell mining. Like Zone C, the proposed project calls for replacement of existing utilities to a depth of 91 cm below surface. Intact strata of St. Johns I or II affiliation are situated very close to the surface, within 15 to 20 cm. These strata are composed primarily of whole shell with abundant vertebrate faunal bone, St. Johns period pottery sherds, and some marine shell tools. One STP intercepted the extant utility trench that will be replaced, and it had been excavated to a depth of only 55 cm. As a result, upwards of 40 cm of intact deposits within this zone of the APE will be disturbed.

#### *8VO2600-Thursby Midden/Hontoon Island Parking Lot*

Testing of site 8VO2600, the Thursby midden, was limited to a single auger test adjacent to the APE. The utilities corridor, in which the main water line will be replaced, also contains buried telephone and electric cables. In order to avoid these utilities, an initial judgmental auger test was emplaced roughly 3 m east of the planned corridor. A single human tooth was recovered at a depth of 70 cm below surface in this first test. The depth of discovery and observed soil characteristics are consistent with previous stratigraphic observations in the vicinity of the APE. In particular, human remains are known to be present across much of the Hontoon Island parking lot, below 70 cm of road fill. At the request of BAR archaeologists, no further testing was conducted within the boundaries of 8VO2600. Because of the limited scope of the auger test, it is unknown if this tooth was in primary context. Moreover, the depth of disturbance within the APE corridor is unknown, although given the presence of multiple utilities it is unlikely that intact archaeological deposits are present there. Regardless, the impact of the proposed project on any deposits in the vicinity of the APE is unknown.

#### *Offsite Reconnaissance*

The results of testing this portion of the APE are consistent with earlier efforts by the St. Johns Archaeological Field School. Archaeological sites were not expected to occur any significant distance from extant river channel segments. Testing immediately adjacent to site 8VO202 demonstrated that there is a low-density non-shell midden that terminates roughly 20 m from the lateral extent of shell midden. The chronological association between the shell and non-shell component of the site is unknown. Regardless, continued testing along the trail segment immediately south of site 8VO202

demonstrated that the trail is built over a low-lying swamp that lacks any evidence for archaeological deposits. In addition, the intersection of the swamp and higher elevations to the south, in the vicinity of the cabins, was tested by several STPs. Cultural materials were identified during testing, but these were all restricted to a highly disturbed surface stratum. It would appear that the long-term effect of trail regrading was the dispersal of midden materials across much of the trail and campsites. The proposed project will not impact any *in situ* archaeological deposits in this segment of the APE.

### RECOMMENDATIONS

Based on the results of fieldwork, we have several recommendations regarding the potential impact of cultural resources within the project APE:

1. Excavation of the utility corridor from the main line tie-in at the north end of the parking lot to the directional drill location at the south end of the parking lot should be monitored with supervision of a professional archaeologist.
2. Zone A at 8VO202 should be closely monitored by a professional archaeologist. Further work may be necessary to characterize the nature and significance of intact deposits.
3. Zone B should be monitored by a professional archaeologist during road excavation and trenching.
4. Trenching within Zone C should not significantly impact archaeological deposits as long as depth specifications for the trench are adhered to. However, monitoring by a professional archaeologist will be necessary for excavation in the vicinity of the pavilion, where isolated human skeletal elements were recovered from disturbed strata.
5. Zone D should be monitored by a professional archaeologist during trenching.
6. As part of its project specifications, the DEP has suggested that “earth dikes” be built of “suitable material” should excavations encounter wet deposits. We recommend that no excavation for such materials should occur within the boundaries of 8VO202 or 8VO2600.
7. Any ancillary activities that may impact subsurface deposits in the vicinity of site 8VO2600, and Zones A, B, and D at 8VO202 should be avoided.
8. Work outside of the boundaries of 8VO202 and 8VO2600 can proceed without further archaeological intervention.

## REFERENCES CITED

- Archaeological Consultants, Inc. and Janus Research  
2001 *Phase III Mitigative Excavations at Lake Monroe Outlet Midden (8VO53), Volusia County, Florida*. Report Submitted to U.S. Department of Transportation Federal Highway Administration and Florida Department of Transportation District Five by Archaeological Consultants, Inc. and Janus Research.
- Aten, Lawrence E.  
1999 Middle Archaic Ceremonialism at Tick Island, Florida: Ripley P. Bullen's 1961 Excavations at the Harris Creek Site. *The Florida Anthropologist* 52:131-200.
- Austin, Robert J.  
2004 *Multidisciplinary Investigations at West Williams, 8hi509: An Archaic Period Archaeological Site Located within Florida Gas Transmission Company's Bayside Lateral Pipeline Corridor, Hillsborough County, Florida*. Report Submitted to Florida Gas Transmission Company, Inc. by Southeastern Archaeological Research.
- Austin, Robert J. and Richard W. Estabrook  
2000 Chert Distribution and Exploitation in Peninsular Florida. *The Florida Anthropologist* 53:116-130.
- Borremans, Nina T.  
1990 *The Paleoindian Period*. Florida Historical Contexts.  
[<http://www.flheritage.com>]
- Bullen, Ripley  
1975 *A Guide to the Identification of Florida Projectile Points*. Kendall Books, Gainesville.
- Bullen, Ripley P.  
1955 Carved Owl Totem, Deland, Florida. *The Florida Anthropologist* 8:61-73.  
  
1972 The Orange Period of Peninsular Florida. In *Fiber-Tempered Pottery in Southeastern United States and Northern Colombia: Its Origins, Context, and Significance*, edited by R. P. Bullen and J. B. Stoltman. Florida Anthropological Society Publications 6, Gainesville.

Clausen, C. J.

1964 *The A-356 Site and the Florida Archaic*. Masters Thesis, University of Florida.

Clausen, C. J., A. D. Cohen, Cesare Emiliani, J. A. Holman and J. J. Stipp

1979 Little Salt Springs, Florida: A Unique Underwater Site. *Science* 203:609-614.

Clench, William J. and Ruth D. Turner

1956 Freshwater Mollusks of Alabama, Georgia and Florida. *Bulletin of the Florida State Museum, Biological Sciences* 1:108-111.

Cook, Anthony

1985a *Euglandina* Feeding Strategies. *Malacologia* 26:182-190.

1985b Functional Aspects of Trail Following by the Carnivorous Snail *Euglandina Rosea*. *Malacologia* 26:173-181.

Cooke, C. Wythe

1939 *Scenery of Florida Interpreted by a Geologist*. Florida Geological Survey Bulletin no. 17, Tallahassee.

Cordell, Ann S.

2004 Paste Variability and Possible Manufacturing Origins of Late Archaic Fiber-Tempered Pottery from Selected Sites in Peninsular Florida. In *Early Pottery: Technology, Function, Style and Interaction in the Lower Southeast*, edited by R. Saunders and C. T. Hays, pp. 63-104. University of Alabama Press, Tuscaloosa.

Daniel, I. Randolph and Michael Wisenbaker

1987 *Harney Flats: A Florida Paleo-Indian Site*. Baywood Publishing Company, Inc., Farmingdale, New York.

Darby, Philip C., Robert E. Bennetts, Steven J. Miller and H. Franklin Percival

2002 Movements of Florida Apple Snails in Relation to Water Levels and Drying Events. *Wetlands* 22:489-498.

Doran, Glen H. (editor)

2002 *Windover: Multidisciplinary Investigations of an Early Archaic Florida Cemetery*. University of Florida Press, Gainesville.

- Dunbar, James S., Michael K. Faught and David S. Webb  
1988 Page/Ladson (8je591): An Underwater Paleo-Indian Site in Northwestern Florida. *The Florida Anthropologist* 41:442-452.
- Dunbar, James S. and Ben Waller  
1983 A Distribution Analysis of the Clovis/Suwannee Paleo-Indian Sites of Florida: A Geographic Approach. *The Florida Anthropologist* 36:18-30.
- Dunbar, James S. and S. David Webb  
1996 Bone and Ivory Tools from Submerged Paleoindian Sites in Florida. In *The Paleoindian and Early Archaic Southeast*, edited by D. G. Anderson and K. E. Sassaman, pp. 331-. University of Alabama Press, Tuscaloosa.
- Endonino, Jon C.  
2003a Pre-Ceramic Archaic Burial Mounds Along the St. Johns River, Florida. Paper presented at the 59th Annual Southeastern Archaeological Conference, Charlotte, NC.  
  
2003b Hontoon Island Reconnaissance Survey. In *St. Johns Archaeological Field School 2000-2001: Blue Springs and Hontoon Island State Parks*, edited by K. E. Sassaman, pp. 91-108. Technical Report 4. Laboratory of Southeastern Archaeology, Department of Anthropology, University of Florida, Gainesville.  
  
2007 A Reevaluation of the Gainesville, Ocala, and Lake Panasoffkee Quarry Clusters. *The Florida Anthropologist* 60:77-96.
- Faught, Michael K.  
2004 The Underwater Archaeology of Paleolandscapes, Apalachee Bay, Florida. *American Antiquity* 69:275-289.
- Faught, Michael K. and Joseph F. Donoghue  
1997 Marine Inundated Archaeological Sites and Paleofluvial Systems: Examples from a Karst-Controlled Continental Shelf Setting in Apalachee Bay. *Geoarchaeology: An International Journal* 12:417-458.
- Florida Division of Historical Resources (FDHR)  
2002 *Cultural Resource Management Standards and Operational Manual*. Florida Division of Historical Resources, Tallahassee.

Goggin, John M.

1952 *Space and Time Perspectives in Northern St. Johns Archaeology, Florida*.  
University Press of Florida, Gainesville.

Johnson, Robert E.

2005 *Phase III Archaeological Data Recovery at the Fort Florida Midden Site (8VO48), at Traderscove's Riverside at Debary Development, Volusia County, Florida*. Report Submitted to Traderscove Corp. by Florida Archeological Services, Inc. Jacksonville, Florida.

McGee, Ray M. and Ryan J. Wheeler

1994 Stratigraphic Excavations at Groves' Orange Midden, Lake Monroe, Volusia County, Florida: Methodology and Results. *The Florida Anthropologist* 47:333-349.

Milanich, Jerald T.

1994 *Archaeology of Precolumbian Florida*. University Press of Florida, Gainesville.

Milanich, Jerald T. and Charles Herron Fairbanks

1980 *Florida Archaeology*. New World Archaeological Record. Academic Press, New York.

Miller, James A.

1997 Hydrogeology of Florida. In *The Geology of Florida*, edited by A. F. Randazzo and D. S. Jones, pp. 69-88. University of Florida Press, Gainesville.

Miller, James J.

1998 *An Environmental History of Northeast Florida*. University Press of Florida, Gainesville.

Moore, Clarence B.

1894a Certain Sand Mounds of the St. John's River, Florida. Part I. *Journal of the Academy of Natural Sciences of Philadelphia* 10:4-128.

1894b Certain Sand Mounds of the St. John's River, Florida. Part II. *Journal of the Academy of Natural Sciences of Philadelphia* 10:129-246.

Moore, Clarence B.

- 1999 *The East Florida Expeditions of Clarence Bloomfield Moore*. Classics in Southeastern Archaeology. University of Alabama Press, Tuscaloosa.

Neill, Wilfred T.

- 1964 Trilisa Pond, an Early Site in Marion County, Florida. *The Florida Anthropologist* 17.

- 1971 A Florida Paleoindian Implement of Ground Stone. *The Florida Anthropologist* 24.

Newsom, Lee A.

- 1987 Analysis of Botanical Remains from Hontoon Island (8VO202), Florida: 1980-1985 Excavations. *The Florida Anthropologist* 40:47-84.

- 1994 Archaeobotanical Data from Groves' Orange Midden (8VO2601), Volusia County, Florida. *The Florida Anthropologist* 47:404-417.

- 2002 The Paleoethnobotany of the Archaic Mortuary Pond. In *Windover: Multidisciplinary Investigations of an Early Archaic Florida Cemetery*, edited by G. H. Doran, pp. 191-210. University Press of Florida, Gainesville.

Piatek, Bruce J.

- 1994 The Tomoka Mound Complex in Northeast Florida. *Southeastern Archaeology* 13:109-118.

Purdy, Barbara A.

- 1975 The Senator Edwards Chipped Stone Workshop Site (8-Mr-122), Marion County, Florida: A Preliminary Report of Investigations. *The Florida Anthropologist* 28:178-189.

Quitmyer, Irvy R.

- 2001 Zooarchaeological Analyses. In *Phase III Mitigative Excavations at Lake Monroe Outlet Midden (8VO53), Volusia County, Florida*, pp. 1-25. Report Submitted to U.S. Department of Transportation Federal Highway Administration and Florida Department of Transportation District Five by Archaeological Consultants, Inc. and Janus Research.

Randall, Asa R.

2007 *St. Johns Archaeological Field School 2005: Hontoon Island State Park*. Technical Report 7. Laboratory of Southeastern Archaeology, Department of Anthropology, University of Florida.

Randall, Asa R. and Kenneth E. Sassaman

2005 *St. Johns Archaeological Field School 2003-2004: Hontoon Island State Park*. Technical Report 6. Laboratory of Southeastern Archaeology, Department of Anthropology, University of Florida, Gainesville.

Randazzo, Anthony F. and Douglas S. Jones (editors)

1997 *The Geology of Florida*. University Press of Florida, Gainesville.

Russo, Michael

1990a *The Archaic Period*. Florida Historical Contexts.

1990b *East and Central Florida, 3200 B.P.-A.D. 1565*. Florida Historical Contexts. [<http://www.flheritage.com>]

1993 *The Timucuan Ecological and Historic Preserve Phase III Final Report*. Florida Museum of Natural History.

1996 Southeastern Mid-Holocene Coastal Settlements. In *The Archaeology of the Mid-Holocene Southeast*, edited by K. E. Sassaman and D. G. Anderson, pp. 177-199. University Press of Florida, Gainesville.

2004 Measuring Shell Rings for Social Inequality. In *Signs of Power: The Rise of Cultural Complexity in the Southeast*, edited by J. L. Gibson and P. J. Carr, pp. 26-70. The University of Alabama Press, Tuscaloosa.

Russo, Michael, Ann S. Cordell and Donna Ruhl

1993 *The Timucuan Ecological and Historic Preserve, Phase III Final Report*. Florida Museum of Natural History, Gainesville.

Russo, Michael and Gregory Heide

2002 The Joseph Reed Shell Ring. *The Florida Anthropologist* 55:67-87.

Russo, Michael, Gregory Heide and Vicki Rolland

2002 *The Guana Shell Ring*. Report Submitted to the Florida Department of State Division of Historical Resources.



Russo, Michael, Barbara Purdy, Lee A. Newsom and Ray M. McGee

- 1992 A Reinterpretation of Late Archaic Adaptations in Central-East Florida: Grove's Orange Midden (8VO2601). *Southeastern Archaeology* 11:95-108.

Sassaman, Kenneth E.

- 2003a *Crescent Lake Archaeological Survey 2002: Putnam and Flagler Counties, Florida*. Technical Report 5. Laboratory of Southeastern Archaeology, Department of Anthropology, the University of Florida, Gainesville.

- 2003b New AMS Dates on Orange Fiber-Tempered Pottery from the Middle St. Johns Valley and Their Implications for Culture History in Northeast Florida. *The Florida Anthropologist* 56:5-14.

- 2003c *St. Johns Archaeological Field School 2000-2001: Blue Spring and Hontoon Island State Parks*. Technical Report 4. Laboratory of Southeastern Archaeology, Department of Anthropology, University of Florida, Gainesville.

- 2004 Common Origins and Divergent Histories in the Early Pottery Traditions of the American Southeast. In *Early Pottery: Technology, Function, Style and Interaction in the Lower Southeast*, edited by R. Saunders and C. T. Hays, pp. 23-39. The University of Alabama Press, Tuscaloosa.

Sassaman, Kenneth E. and Asa R. Randall

- 2007 The Cultural History of Bannerstones in the Savannah River Valley. *Southeastern Archaeology* 26:196-211.

Sassaman, Kenneth E., J. Christian Russell and Jon Endonino

- 2000 *St. Johns Archaeological Project Phase I: A GIS Approach to Regional Preservation Planning in Northeast Florida*. Technical Report 3, Laboratory of Southeastern Archeology, Department of Anthropology, University of Florida.

Saunders, Rebecca

- 2004 Spatial Variation in Orange Culture Pottery: Interaction and Function. In *Early Pottery: Technology, Function, Style and Interaction in the Lower Southeast*, edited by R. Saunders and C. T. Hays, pp. 40-62. University of Alabama Press, Tuscaloosa.

Schmidt, Walter

- 1997 Geomorphology and Physiography of Florida. In *The Geology of Florida*, edited by A. F. Randazzo and D. S. Jones, pp. 1-12. University of Florida Press, Gainesville.

Schulderein, Joseph

- 1996 Geoarchaeology and the Mid-Holocene Landscape History of the Greater Southeast. In *Archaeology of the Mid-Holocene Southeast*, edited by K. E. Sassaman and D. G. Anderson, pp. 3-27. University of Florida Press, Gainesville.

Scudder, Sylvia

- 2001 *Archaeopedological Analyses*. Phase Iii Mitigative Excavations at Lake Monroe Outlet Midden (8VO53), Volusia County, Florida. Report Submitted to U.S. Department of Transportation Federal Highway Administration and Florida Department of Transportation District Five by Archaeological Consultants, Inc. and Janus Research.

Sigler-Eisenberg, Brenda, Ann S. Cordell, Richard Estabrook, Elizabeth Horvath, Lee A. Newsom and Michael Russo

- 1985 *Archaeological Site Types, Distribution, and Preservation within the Upper St. Johns River Basin, Florida*. Florida State Museum Miscellaneous Project and Report Series, Number 27. Department of Anthropology, Florida State Museum, University of Florida, Gainesville, Florida.

Ste. Claire, Dana

- 1987 The Development of Thermal Alteration Technologies in Florida: Implications for the Study of Prehistoric Adaptations. *The Florida Anthropologist* 40:203-208.

- 1990 The Archaic in East Florida: Archaeological Evidence from Early Coastal Adaptations. *The Florida Anthropologist* 43:189-197.

USDA

- 1980 *Soil Survey of Volusia County, Florida*. Dept. of Agriculture Soil Conservation Service, Washington.

Watts, William A., Eric C. Grimm and T. C. Hussey

- 1996 Mid-Holocene Forest History of Florida and the Coastal Plain of Georgia and South Carolina. In *Archaeology of the Mid-Holocene Southeast*, edited by K. E. Sassaman and D. G. Anderson, pp. 28-38. University of Florida Press, Gainesville.

Wheeler, Ryan J. and Ray M. McGee

- 1994 Report of Preliminary Zooarchaeological Analysis: Groves' Orange Midden. *The Florida Anthropologist* 47:393-403.

Wheeler, Ryan J., Christine L. Newman and Ray M. McGee

- 2000 A New Look at the Mount Taylor and Bluffton Sites, Volusia County, with an Outline of the Mount Taylor Culture. *The Florida Anthropologist* 53:133-157.

White, William Arthur

- 1970 *The Geomorphology of the Florida Peninsula*. Bureau of Geology Division of Interior Resources Florida, no. 51, Tallahassee.

White, William B.

- 1988 *Geomorphology and Hydrology of Karst Terrains*. Oxford University Press, New York.

Wing, Elizabeth S. and L. McKean

- 1987 Preliminary Study of the Animal Remains Excavated from the Hontoon Island Site. *The Florida Anthropologist* 40:40-46.

Wyman, Jeffries

- 1875 Fresh-Water Shell Mounds of the St. John's River, Florida. *Peabody Academy of Science Memoir* 4.